

POLYCHAR 18 - Short Course

DYNAMIC-MECHANICAL PROPERTIES OF POLYMERS



A project of the IUPAC Division IV (POLYMER DIVISION)

MECHANICAL PROPERTIES OF (POLYMERIC) MATERIALS
UNDER THE INFLUENCE OF
DYNAMIC LOAD AND TEMPERATURE

mechanical modulus as a function of load, temperature, time
transitions, relaxations

simple deformations in a solid

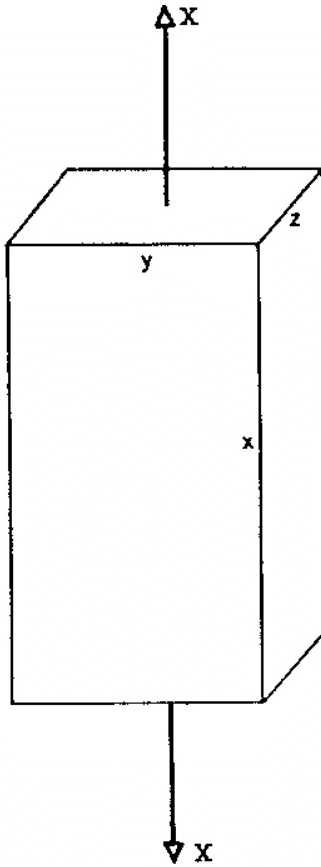

simple extension

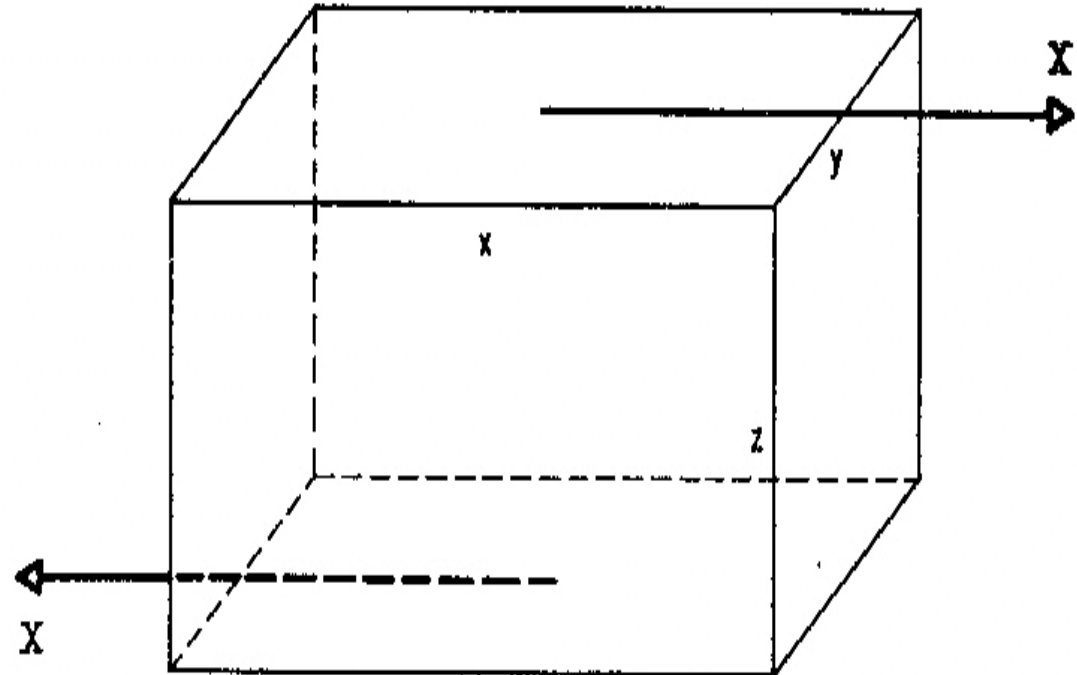

simple shear deformation
(also in liquids possible)

simple stress in a shear deformation

σ_{ii} = normal stress; τ_{ij} = shear stress

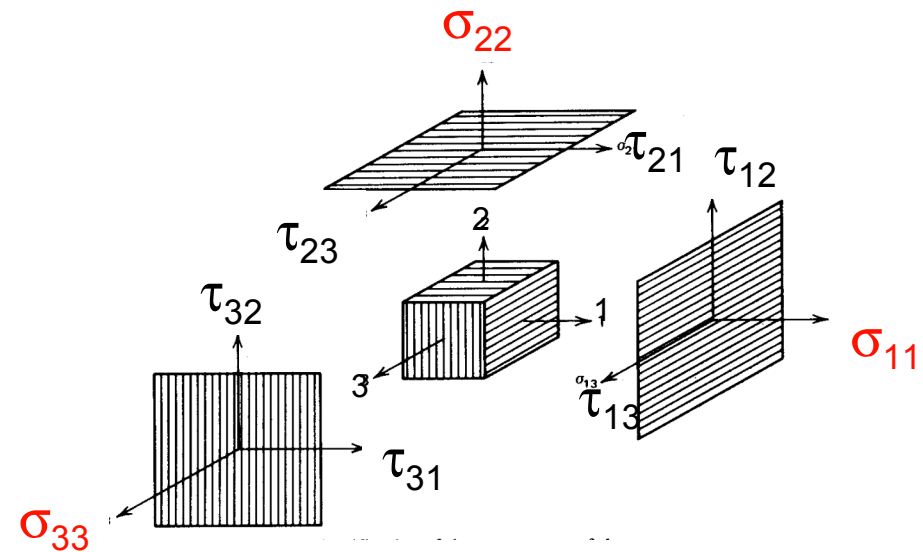
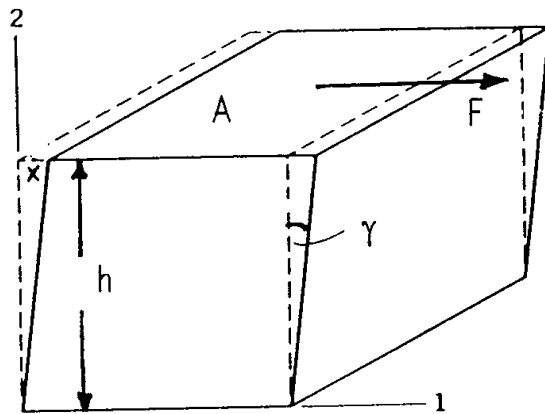

The total stress σ_{ij} is a second rank tensor composed of normal and shear components

(ideal) energy elasticity

- caused by deformation of bond angles and bond length at small deformations
- the energy is stored and completely released after the load is removed
- there is no (internal) friction

$$\sigma = \frac{F_{\text{normal}}}{A_0}$$

$$\tau = \frac{F_{\text{in plane}}}{A_0}$$

$$\sigma = E \cdot \varepsilon \quad \varepsilon = \frac{L - L_0}{L_0} = \frac{\Delta L}{L_0} = \lambda - 1$$

$$\tau = G \cdot \gamma$$

$$\varepsilon = \sigma \cdot \frac{1}{E} = \sigma \cdot J$$

ε = strain; λ = uniaxial deformation ratio; γ = shear (angle); F = force [N]; A_0 = initial area
 E = Young modulus [Pa]; G = shear modulus [Pa]; J = compliance [Pa⁻¹]

Stress Causes Strain

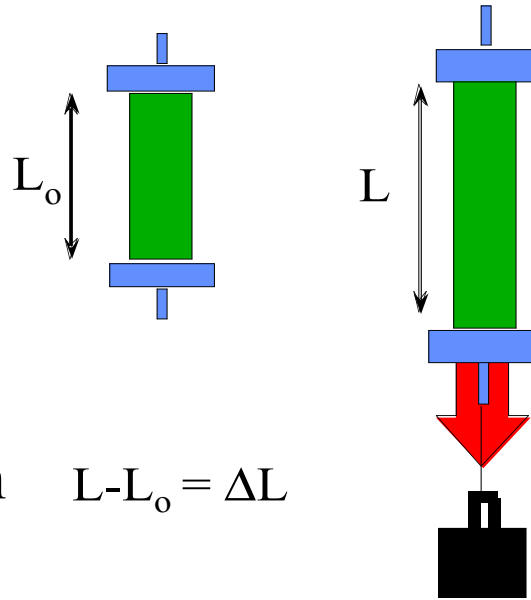

elongation $L - L_0 = \Delta L$

Cauchy or
Engineering Strain

$$\epsilon = \Delta L / L_0$$

Hencky or
True Strain

$$\epsilon = \ln (\Delta L / L_0)$$

Kinetic Theory
of Rubber Strain

$$\epsilon = 1/3 \{L / L_0 - (L_0 / L)^2\}$$

Kirchhoff Strain

$$\epsilon = 1/2 \{ (L / L_0)^2 - 1 \}$$

Murnaghan Strain

$$\epsilon = 1/2 \{ 1 - (L_0 / L)^2 \}$$

The different definitions of tensile strain
become equivalent at very small deformations.

The stress [$\text{Pa} = \text{N}/\text{m}^2$] refers to the initial cross section

Stress and strain are principally time-dependent

stress can “*relax*” (at constant strain)

elongation can “*creep*” (at constant stress)

ideal stress-strain diagram

in the elastic limit: Hooke's Law

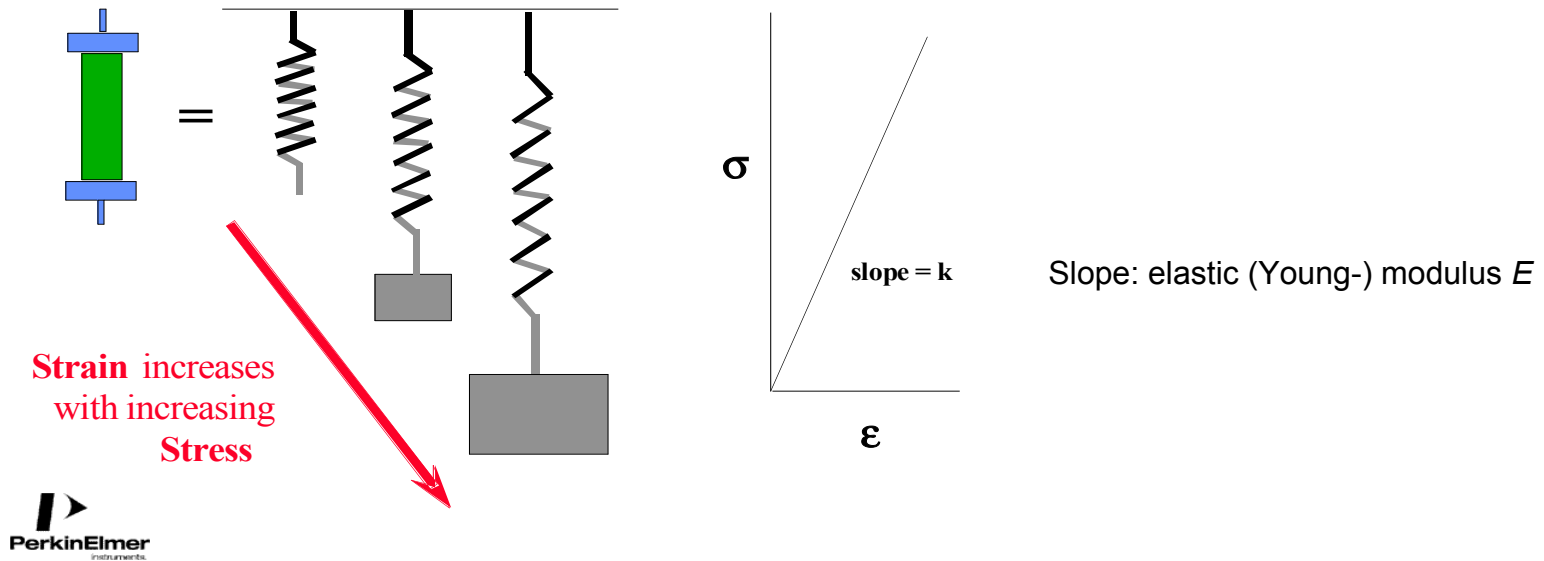

the major types of moduli

extension	→ Young modulus E
shear	→ shear modulus G
compression	→ bulk modulus B
bending*	→ bending modulus E_b

*three-point bending, 4 point bending

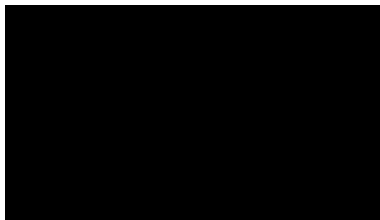
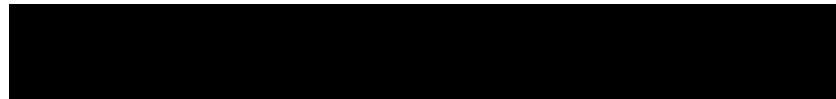

The lateral strain ϵ_{lat} is the strain normal to the uniaxial deformation.

the different moduli can be converted into one another, see D. Ferry

so that for elastomers:

$$\mu \cong 0.5 \rightarrow E \cong 3 \cdot G$$

The volume change on deformation is for most elastomers negligible so that $\mu=0.5$ (isotropic, incompressible materials).

In a sample under small uniaxial deformation!!

The lateral strain ε_{lat} is the strain normal to the uniaxial deformation.

shear in an ideal (Newtonian) liquid

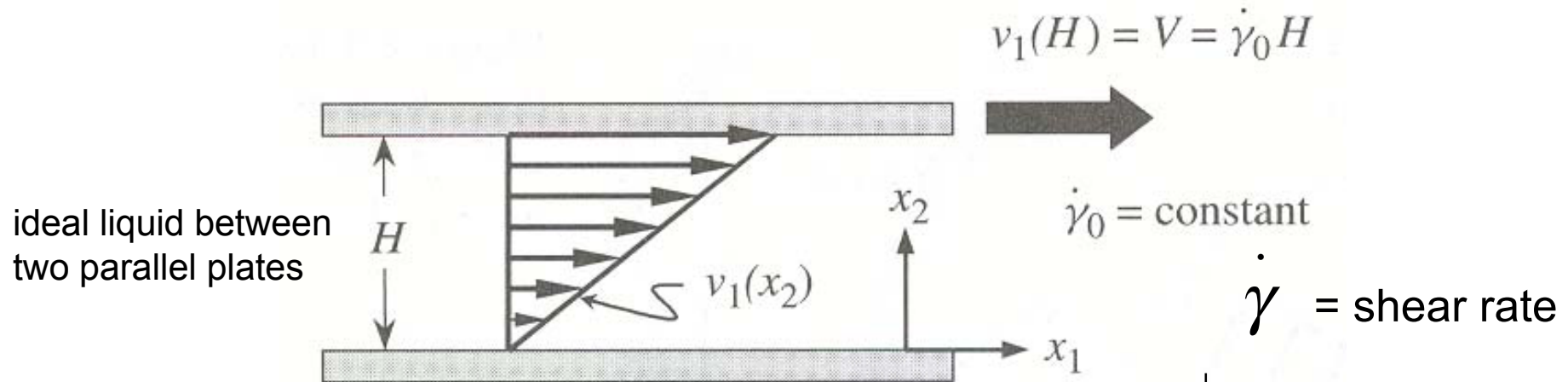

an ideal liquid shows no elasticity

$$\tau \sim \text{grad } v$$

$$\tau = \eta \cdot \text{grad } v = \eta \cdot \frac{dv}{dx_2} = \eta \cdot \dot{\gamma}$$

η = dynamic viscosity [Pa s]; 1 centipoise = 1 mPa s

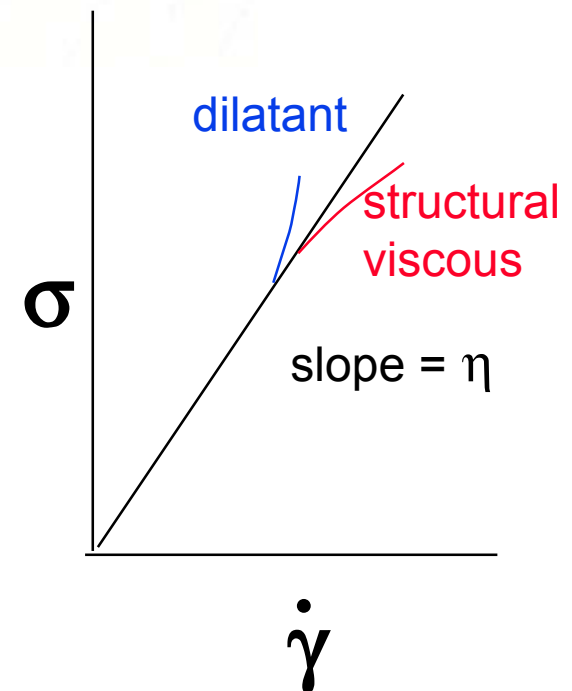

important rheometer types for viscous samples

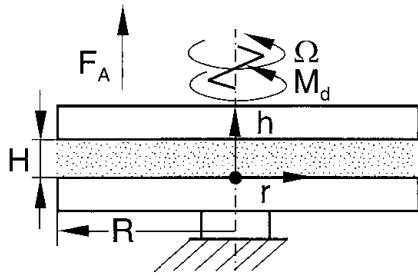
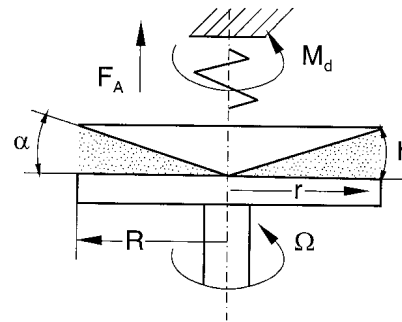
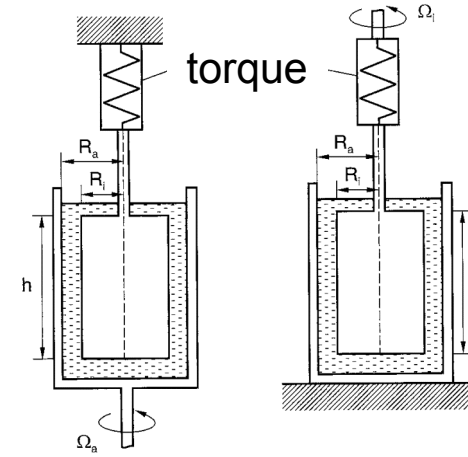

plate-plate



cone-plate



Couette

constant shear rate
along the radius

visco-elastic behaviour

James Clerk Maxwell, Phil. Trans. Roy. Soc. London 157 (1867) 52

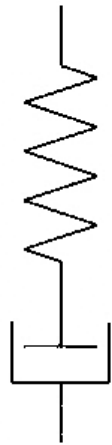

single relaxation time τ

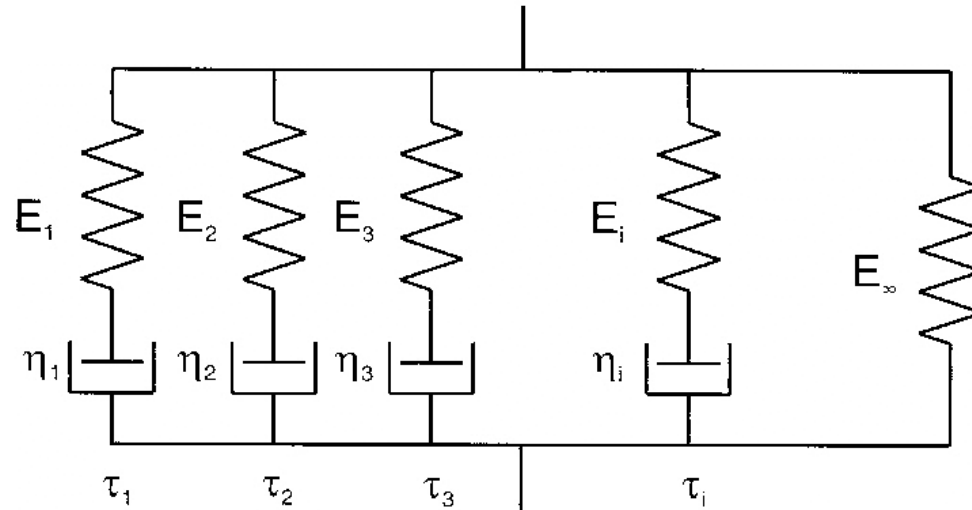

spectrum of relaxation times τ_i

There is mater that shows elastic **and** viscous behaviour (e.g. pitch):
 fast deformation rather elastic, slow deformation rather viscous response

major response types on deformational stress

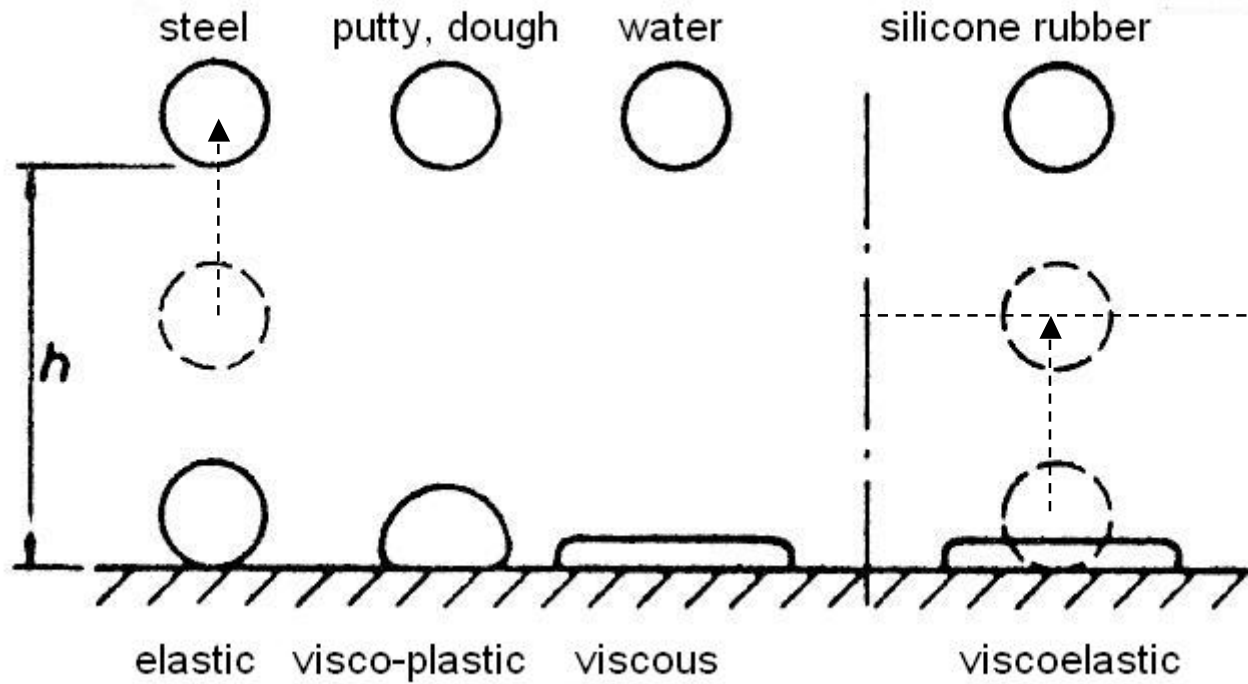

storage and loss of energy

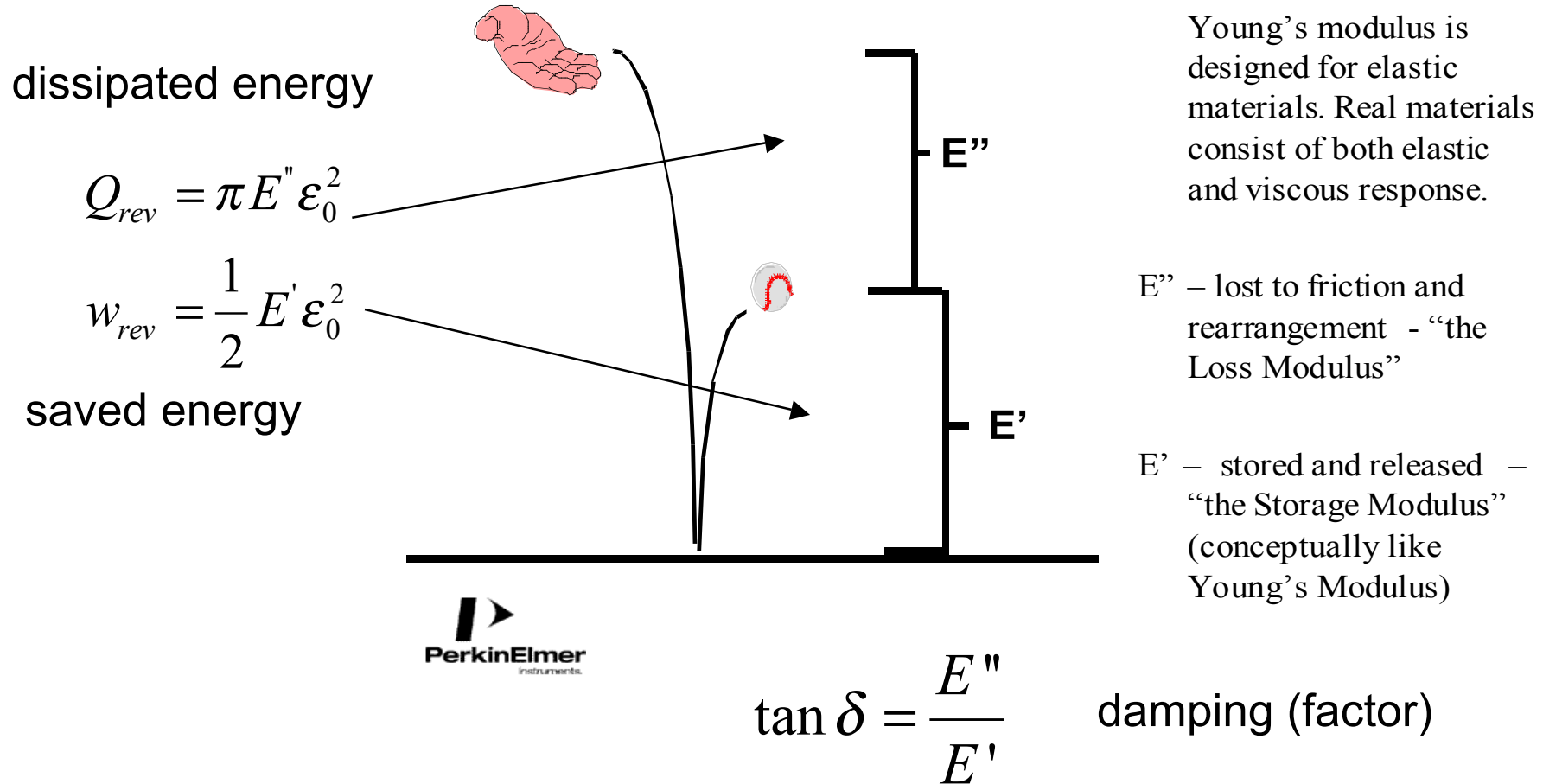

'simple' static stress-strain experiment

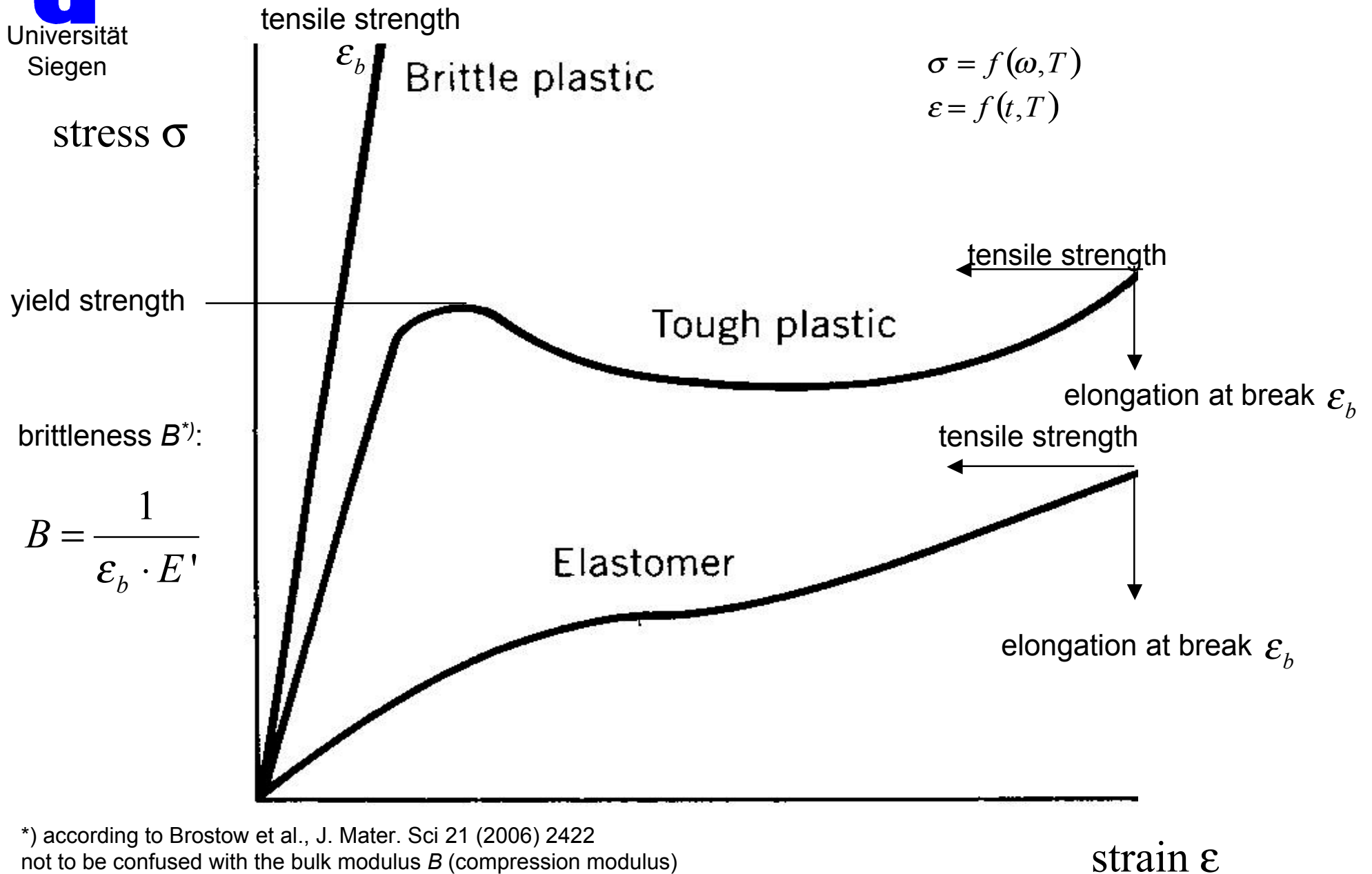

DYNAMIC is important!!

frequency dependence of damping

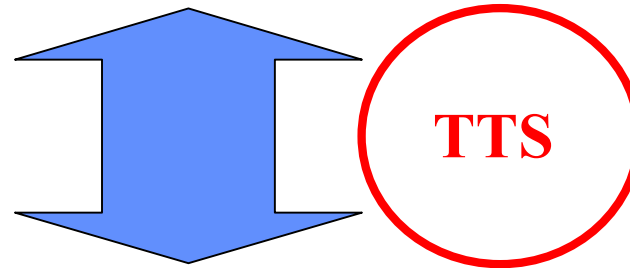

time

temperature

superposition

temperature depending properties (elasticity, flow...)

long term prediction, fatigue...

frequency range and applied technique

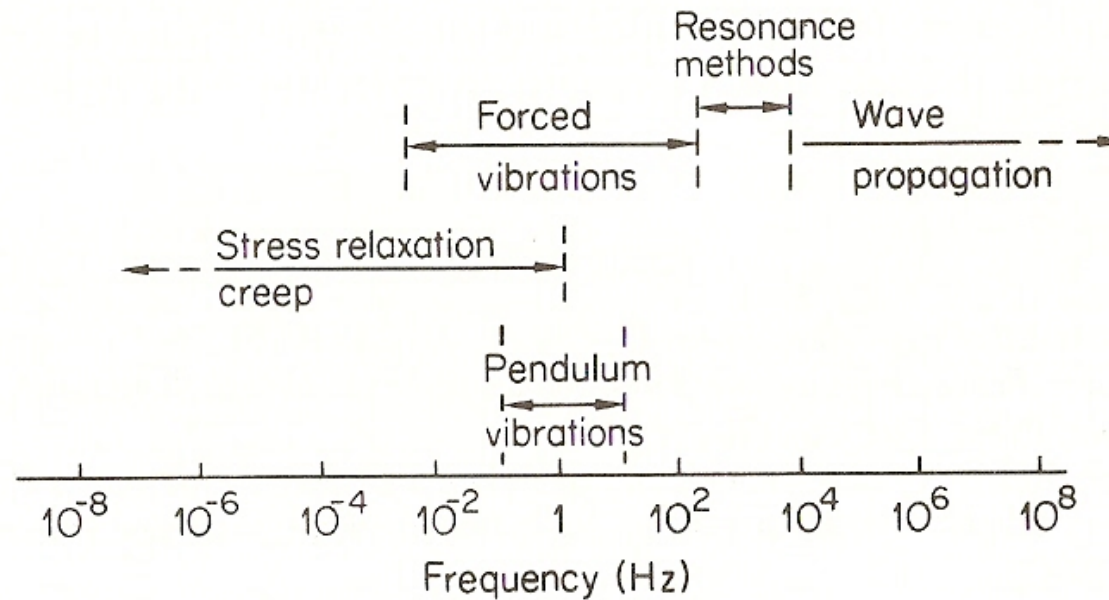

Approximate frequency scales for different experimental techniques (after Becker).

the modern machines can rapidly change the measuring device
so that solid and fluid samples can be measured
and many different modes can be applied

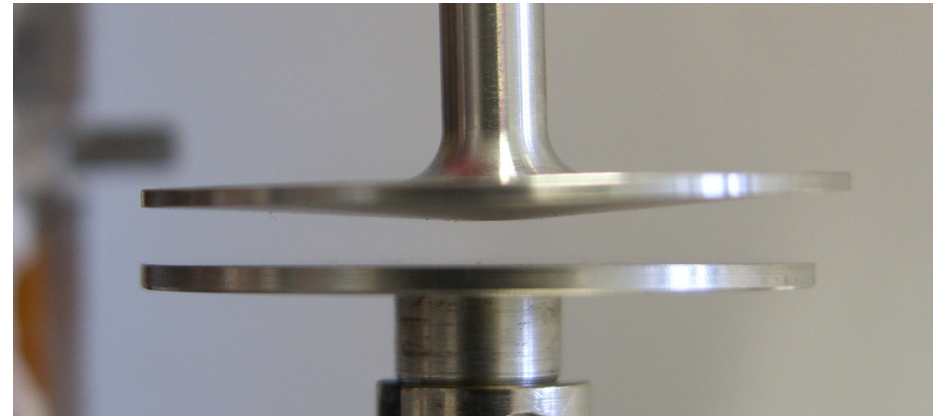

Thermomechanical Analysis
Stress-Strain Curves
Creep Recovery
Stress Relaxation
Dynamic Mechanical Analysis
Solvent Immersed testing

DMA relates:

product properties

molecular structure

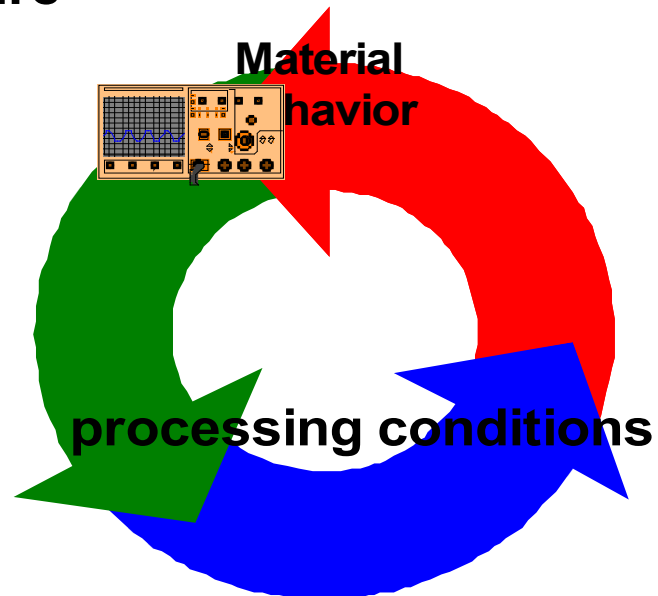
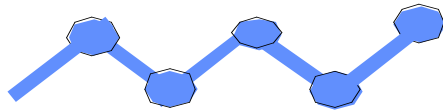

Free damping experiment

logarithmic decrement $\Lambda = \ln \left[\frac{A_n}{A_{n+1}} \right]$

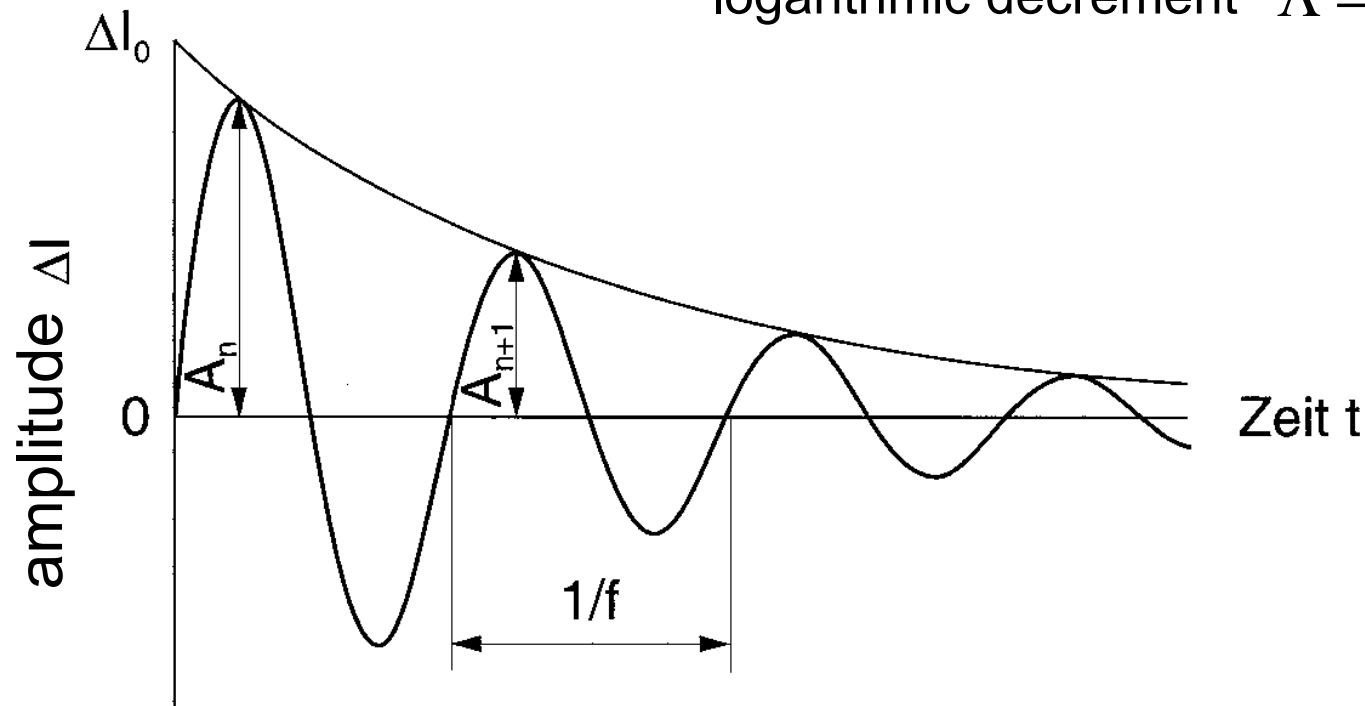

stress and strain are **in phase** in an **ideal energy-elastic** material,
phase angle $\delta = 0^\circ$

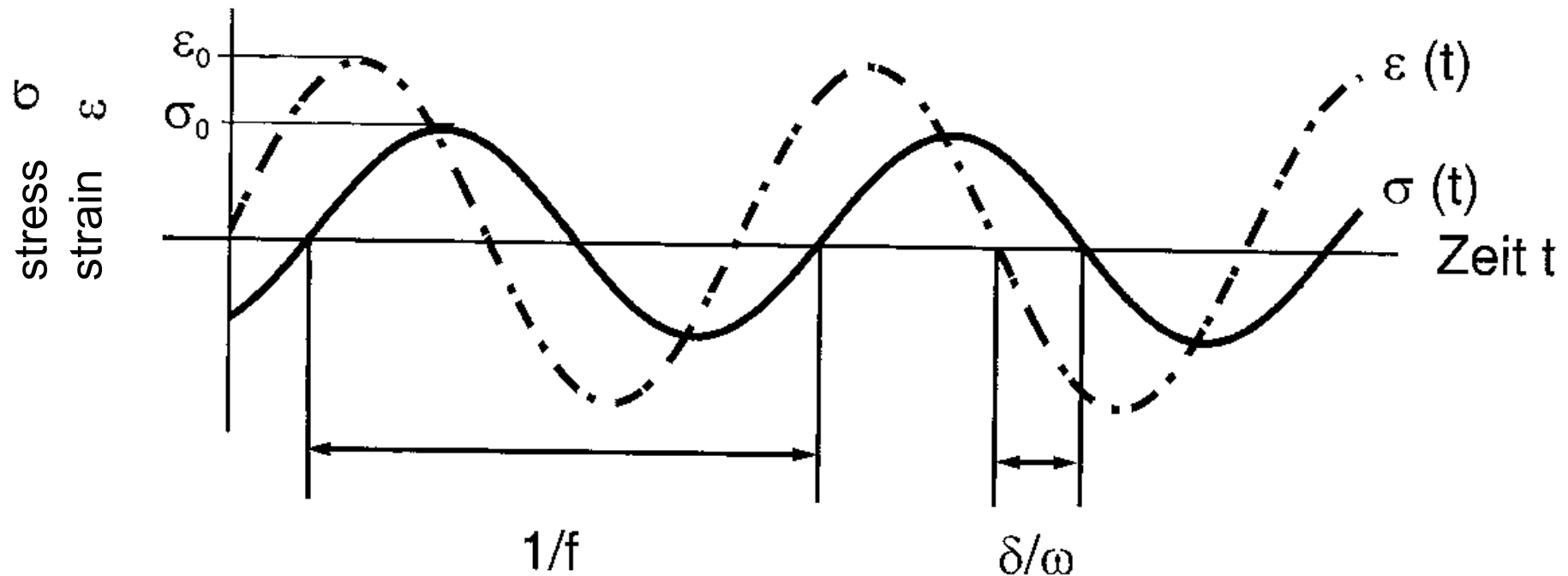

stress and strain are **out of phase** in an **ideal viscous** material,
phase angle $\delta = 90^\circ$

The modulus of a visco-elastic material is a complex physical entity

Theory shows that the modulus is complex and can be split into a real part E' and an imaginary part with E'' :

$$\frac{\sigma}{\varepsilon} = E^* = \frac{\sigma_0}{\varepsilon_0} e^{i\delta} = \frac{\sigma_0}{\varepsilon_0} (\cos \delta + i \sin \delta) = \underbrace{\frac{\sigma_0}{\varepsilon_0} \cos \delta}_{E'} + i \underbrace{\frac{\sigma_0}{\varepsilon_0} \sin \delta}_{E''}$$

$$\Rightarrow E^* = E' + iE''$$

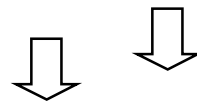

dissipated (loss)

stored

$$W_{rev} = \frac{1}{2} E' \varepsilon_0^2$$

$$Q_{rev} = \pi E'' \varepsilon_0^2$$

Because Young's Modulus isn't enough...

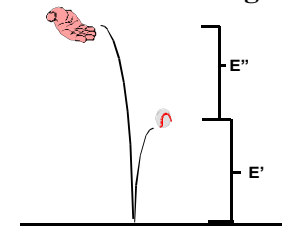

Correlation between moduli and phase angle (damping)

in the Gaussian plane of complex numbers the complex shear modulus G^* , the Young modulus E^* and the complex viscosity η^* can be visualized as

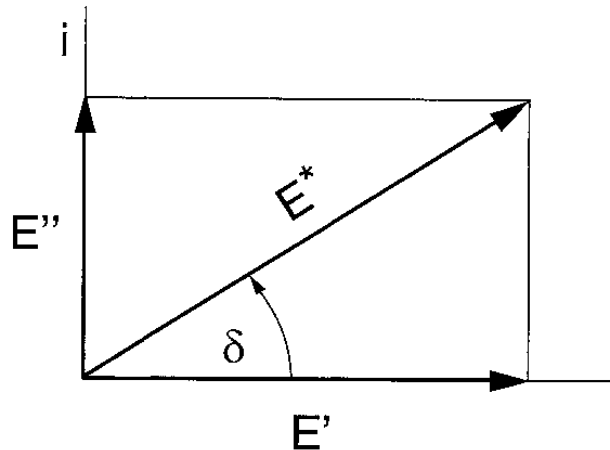

$$|E^*| = \frac{\sigma}{\varepsilon}; \quad |G^*| = \frac{\sigma}{\gamma}; \quad |\eta^*| = \frac{\tau}{\dot{\gamma}}$$

the damping factor D is then given by the tan of the loss angle δ

$$D = \tan \delta$$

D shows a behaviour similar to Λ

Modulus, damping and their correlation with molecular motions

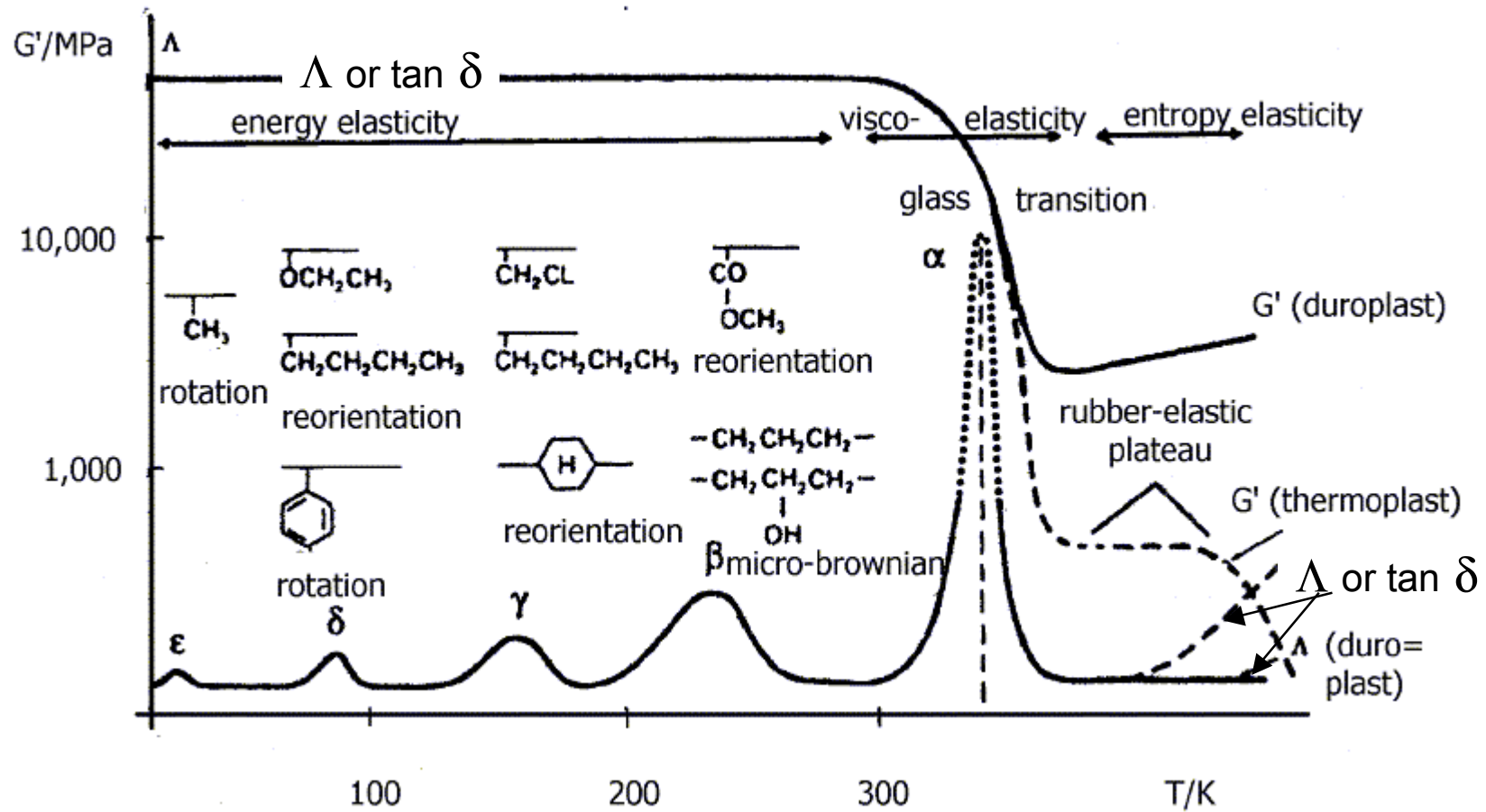

a thermodynamic view at the 'glass transition'

There is not only one glass.
The type of glass depends on the thermal history.

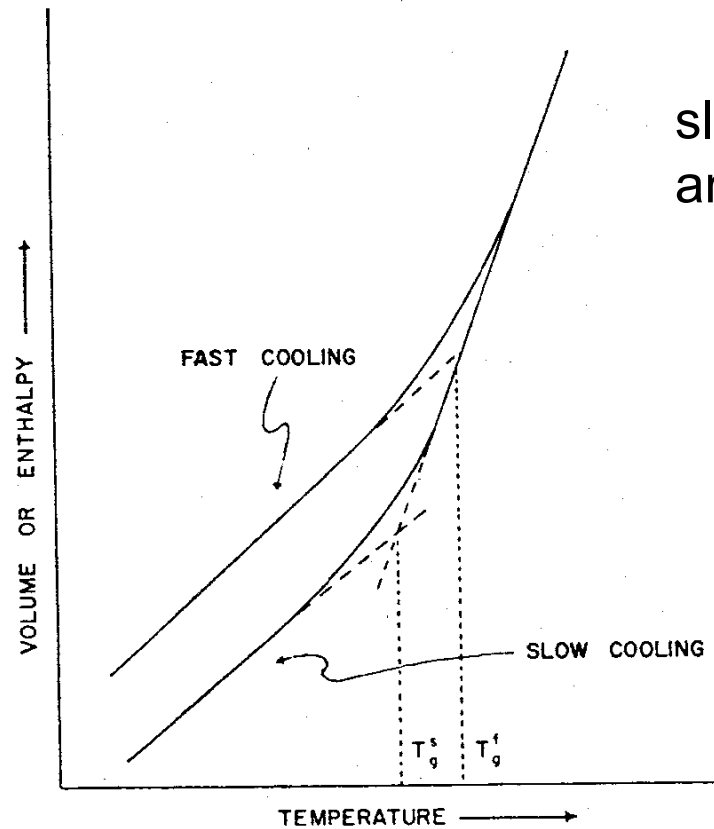

slowly heating can cause annealing

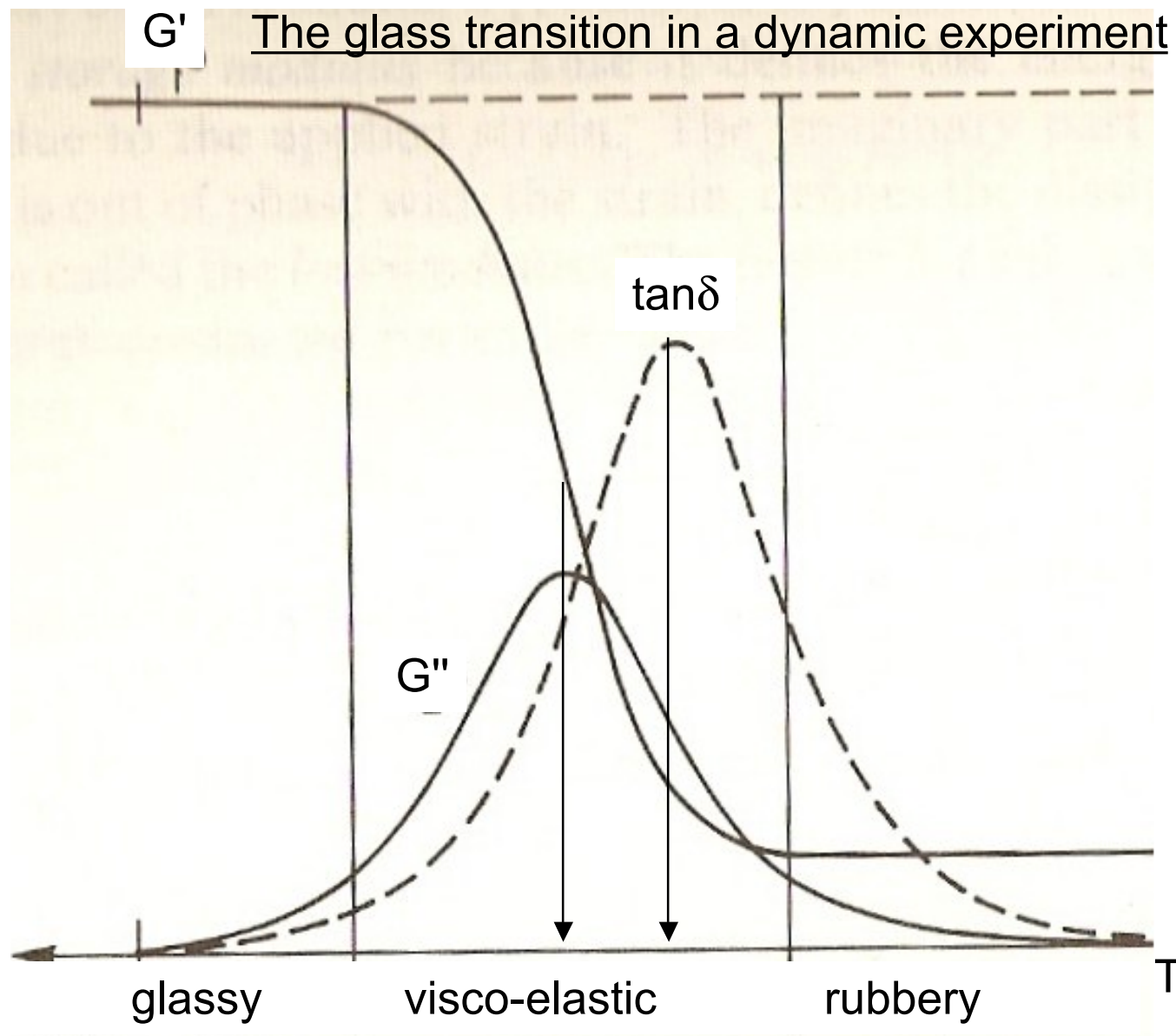

DMA and different molecular parameters

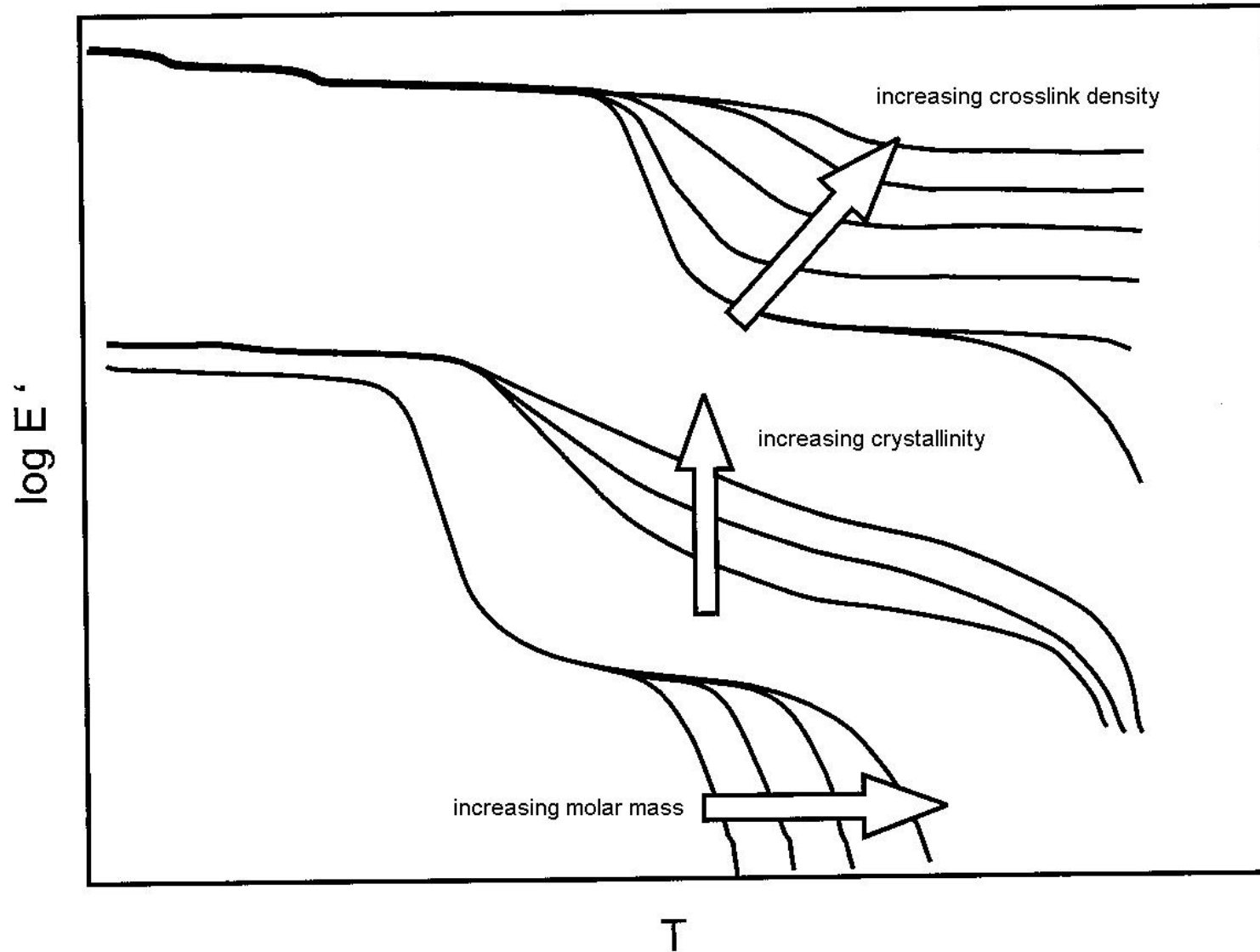

Tg are easily seen, as in PET Film

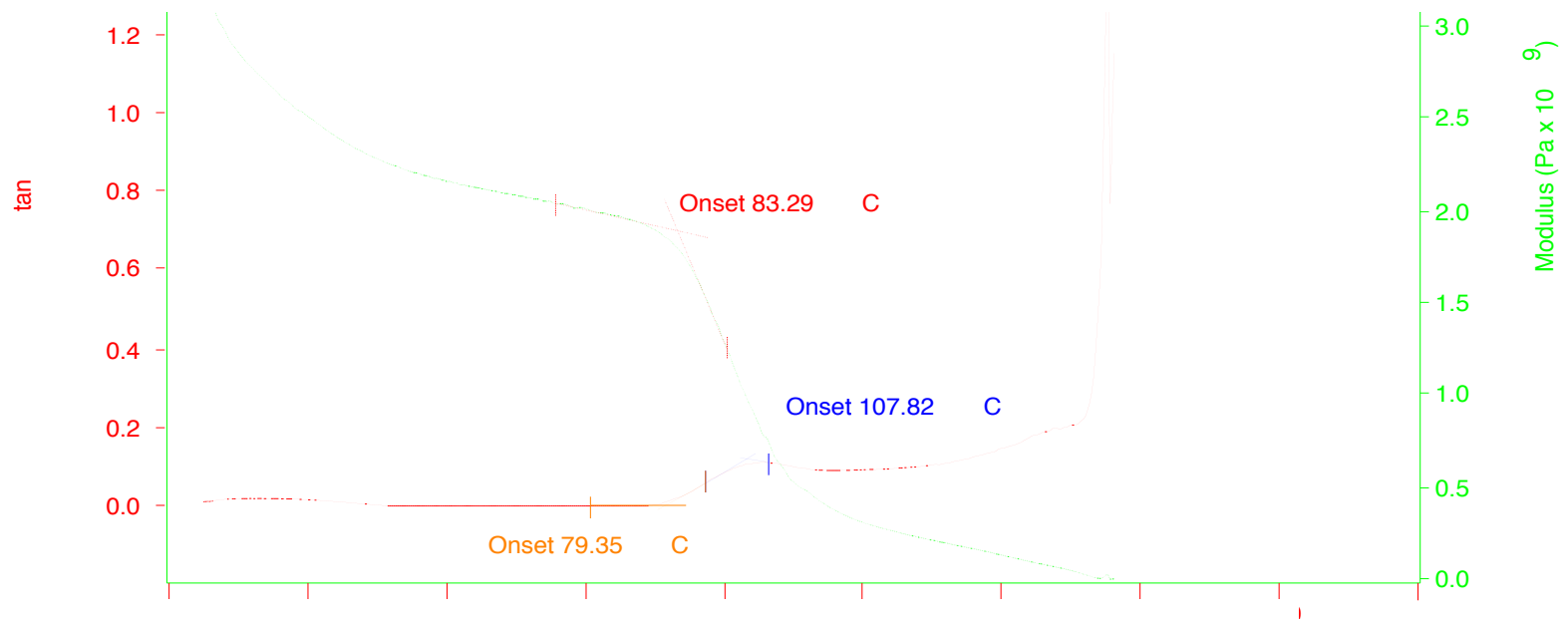

T_g by DMA and DSC

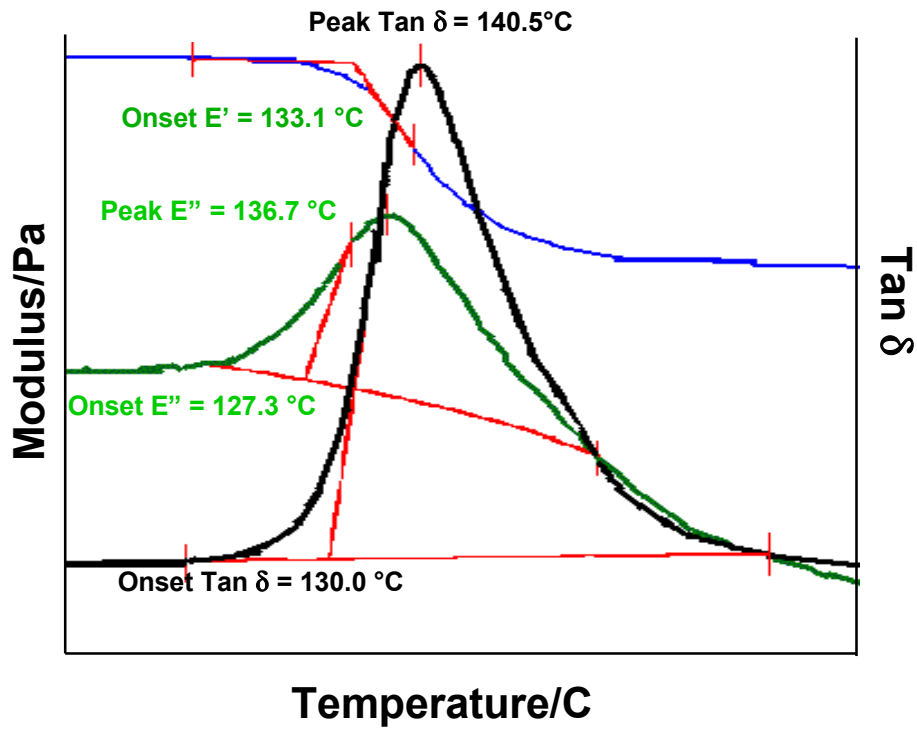

(a)

differential scanning calorimetry

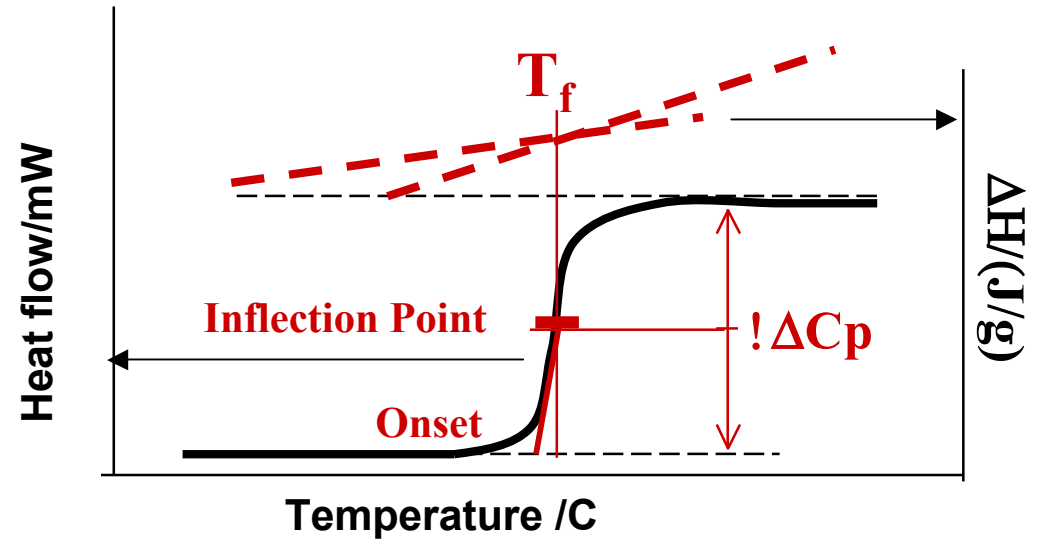

(b)

Operating Range by DMA

(a)

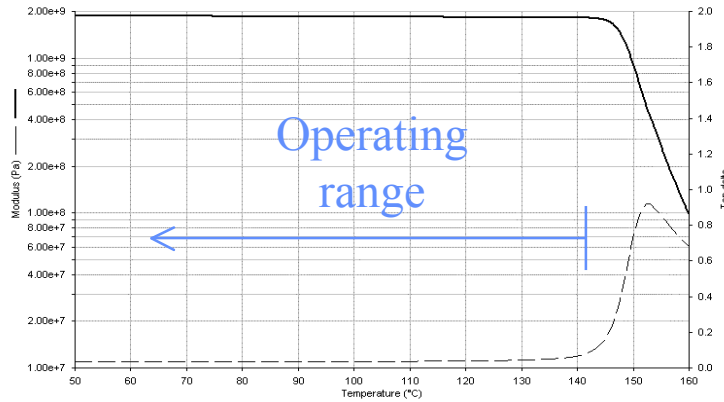

modulus is ok

(b)

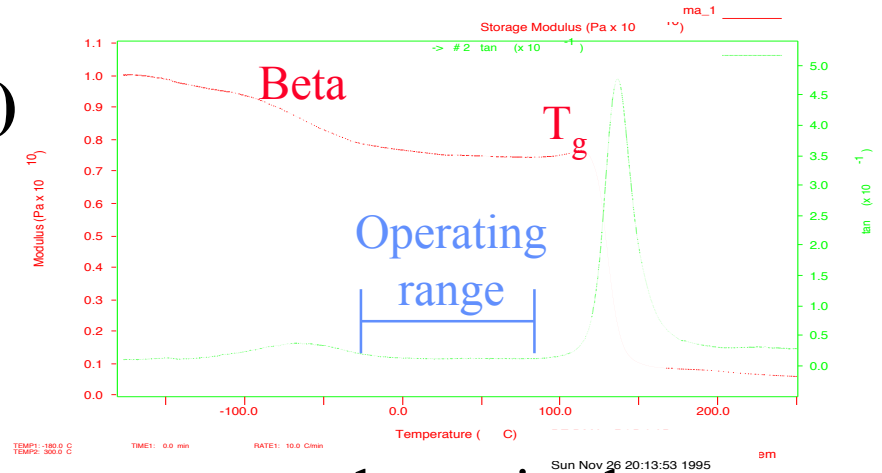

toughness is ok

(c)

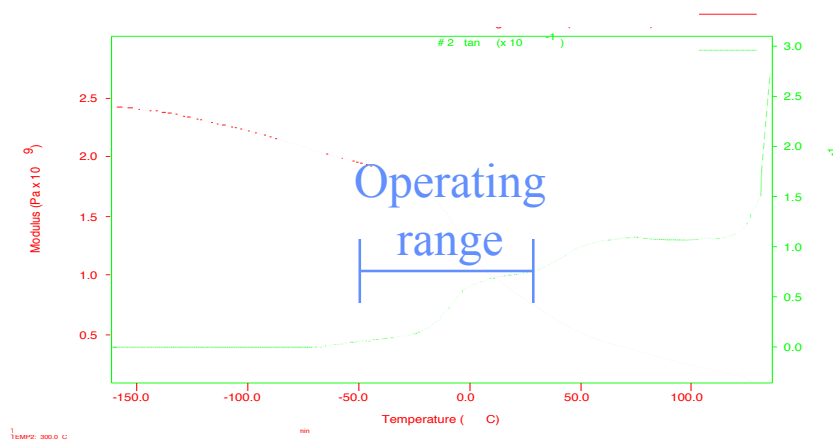

leather-like state

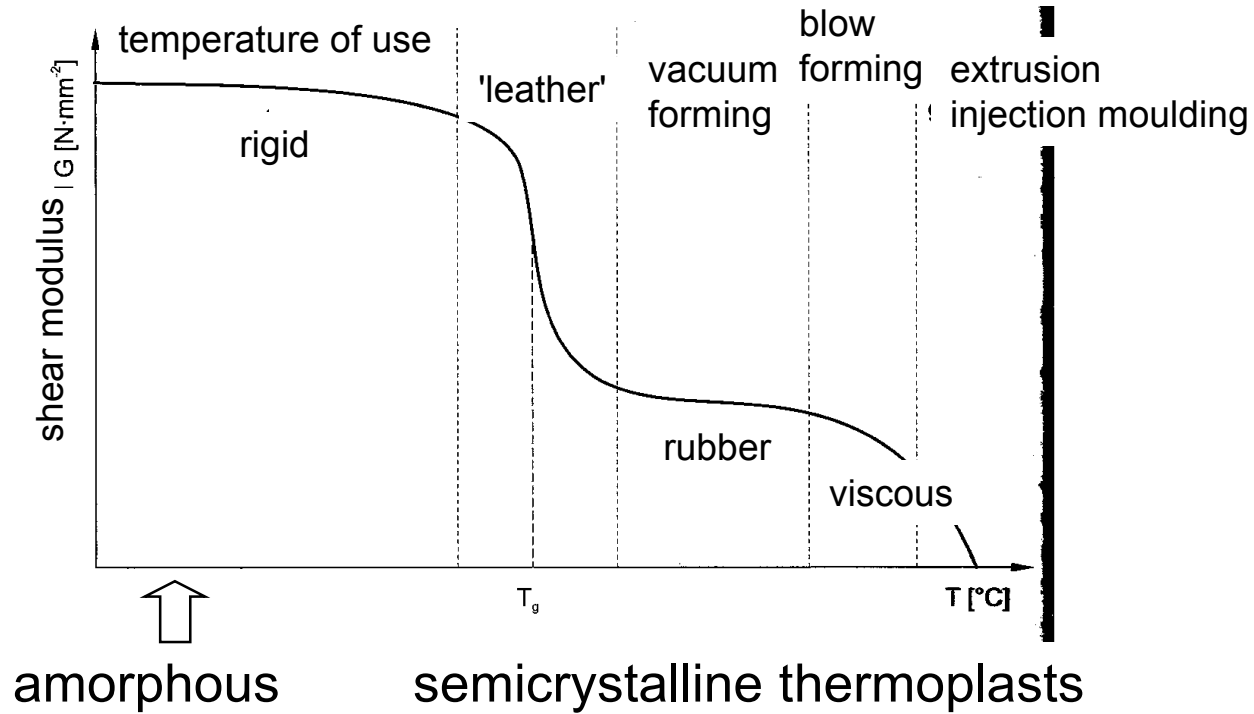

semicrystalline thermoplasts

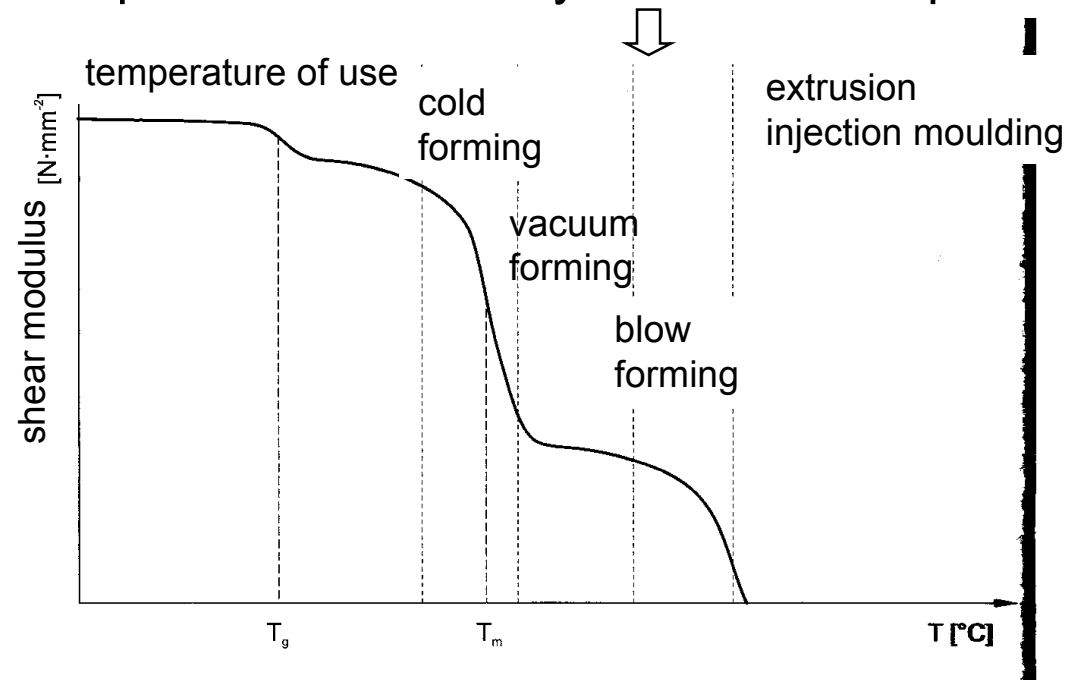

Cold Crystallization in PET seen by DMA and DSC

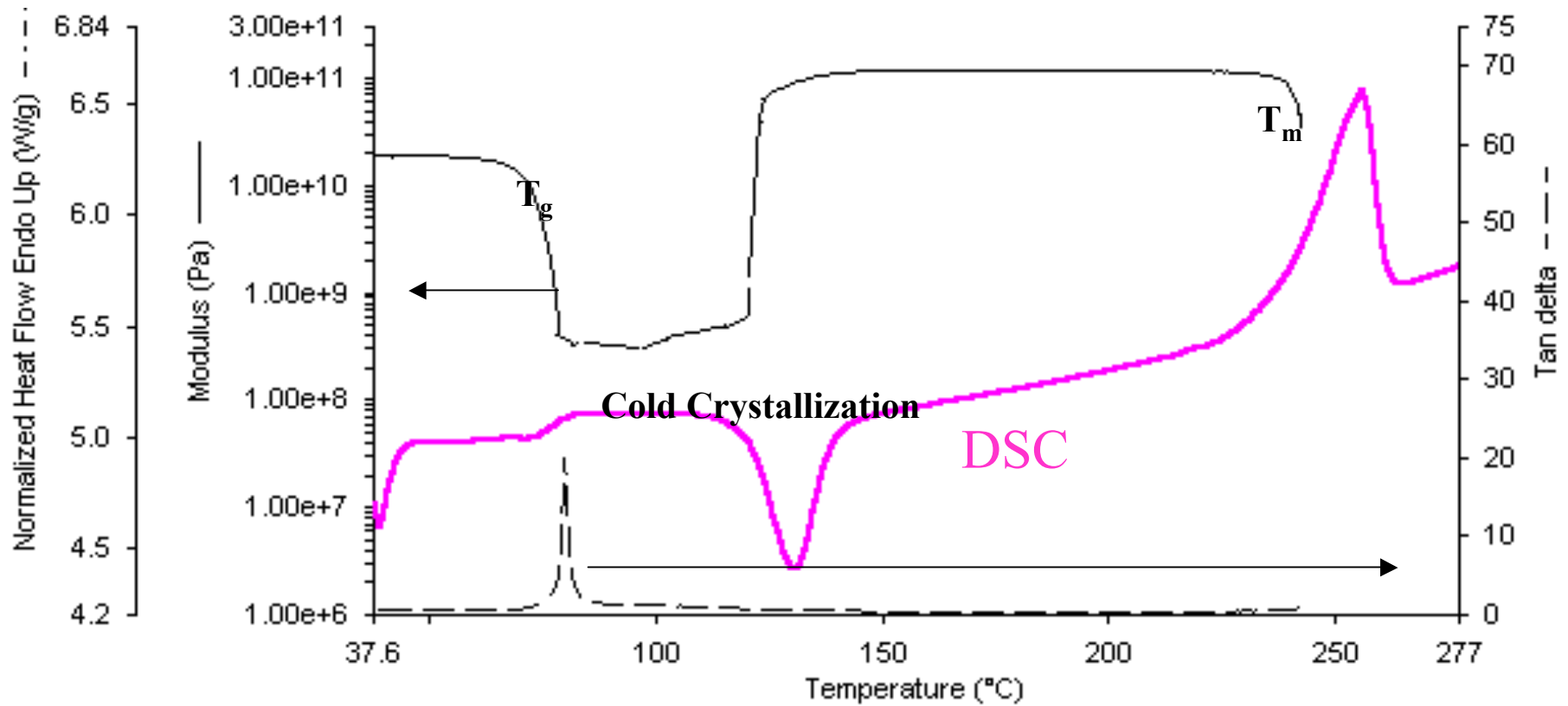

Higher Order Transitions affect toughness

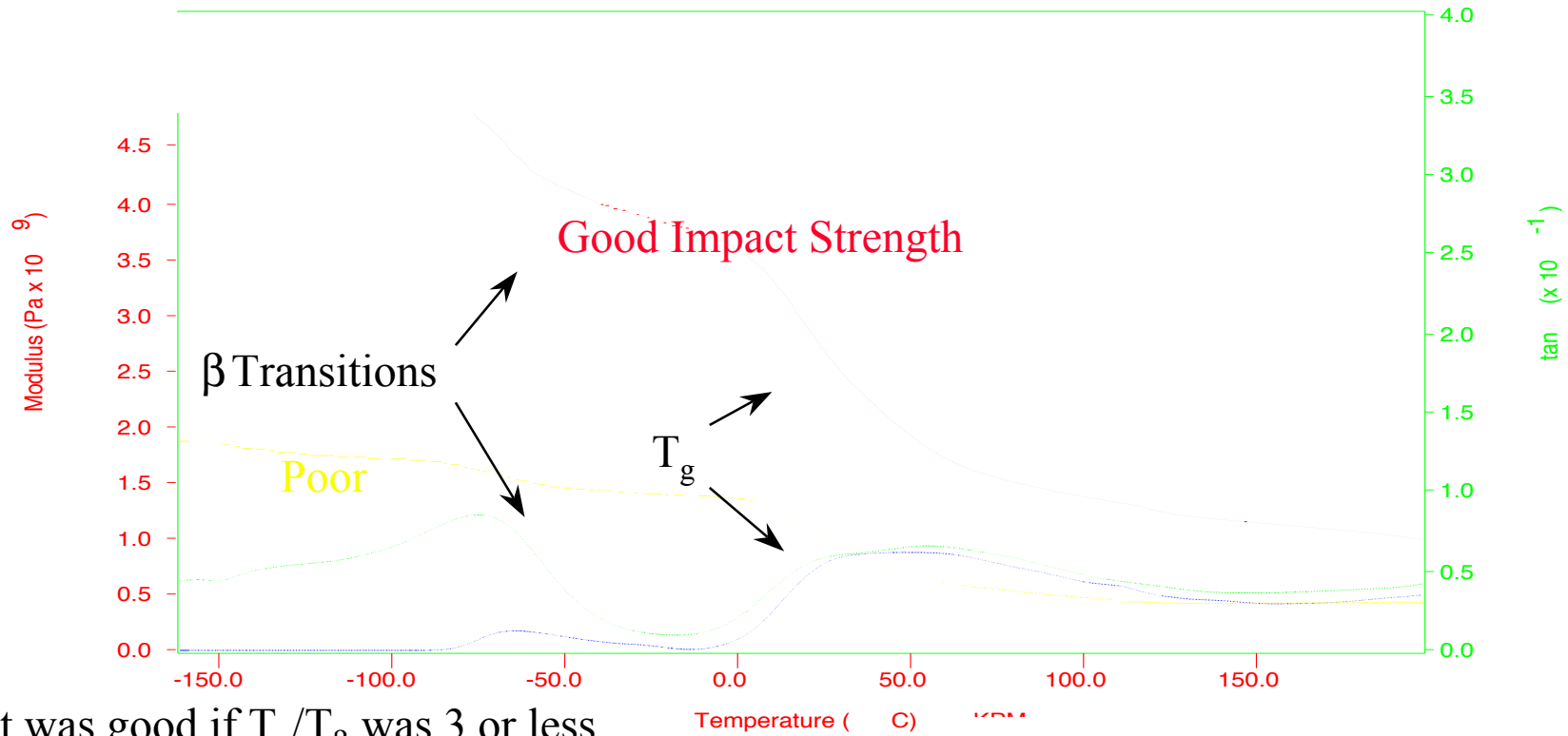

Impact was good if T_g/T_β was 3 or less.

em

stress-relaxation in a silicone rubber

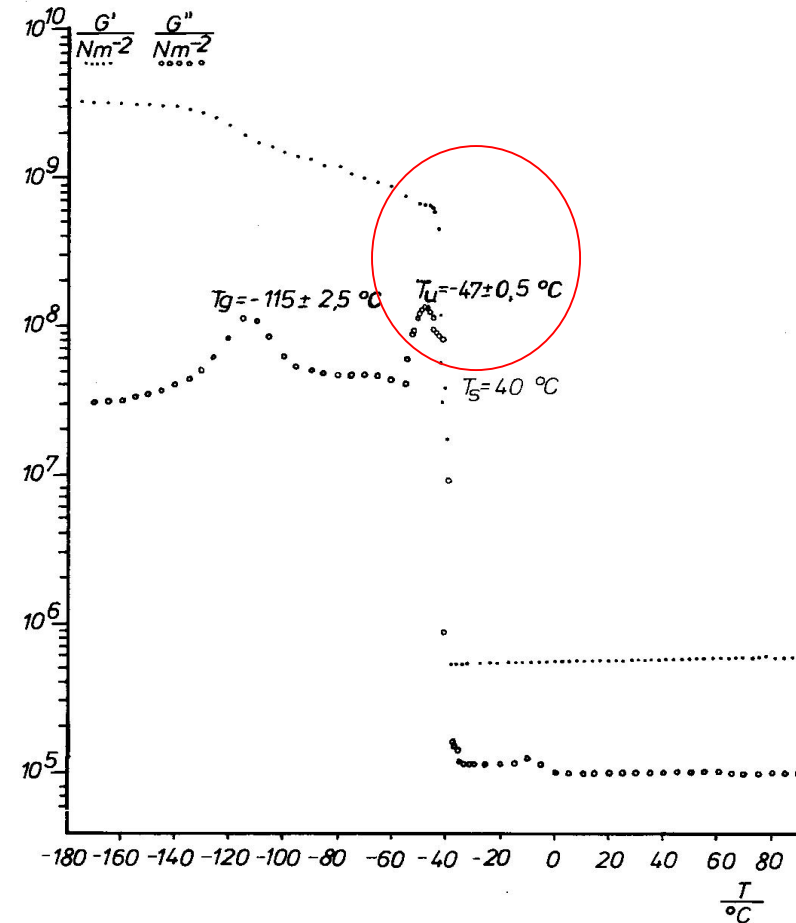
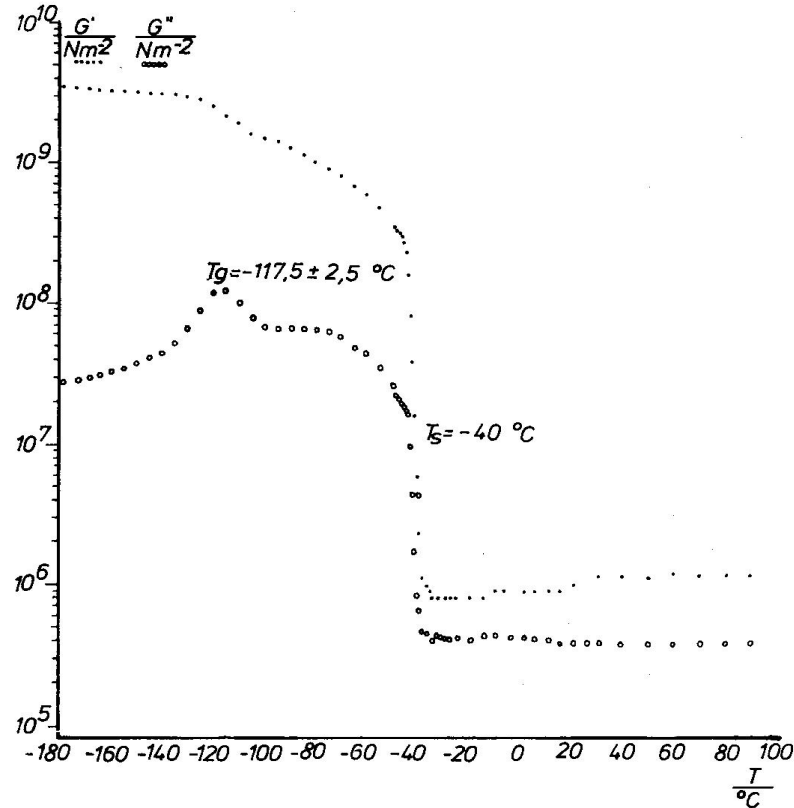

Left: silicon rubber with a glass transition at -117°C and a melting transition at -40°C . Beyond the melting temperature this crosslinked (vulcanised) material shows rubber-elasticity with modulus that increases with the temperature.

Right: also a silicone rubber that contains silicone oil as diluent, as plasticizer. The oil causes a stress-relaxation at the beginning of the melting transition around -47°C .

Blends and Copolymers

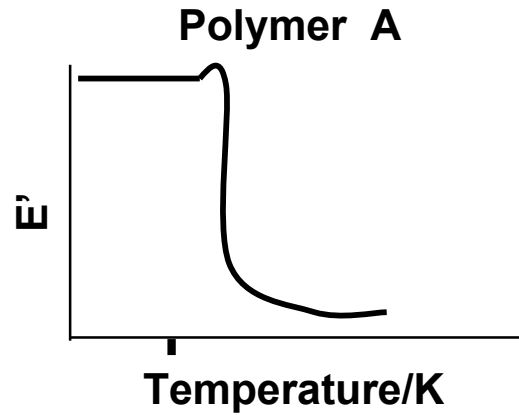

+

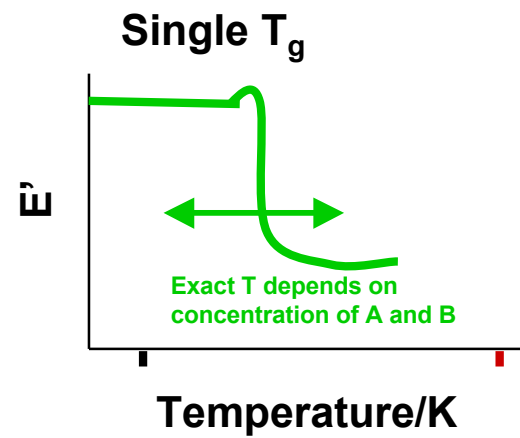
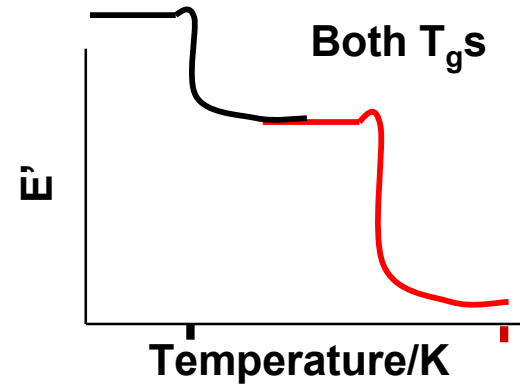
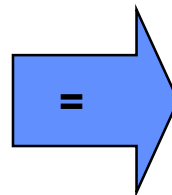
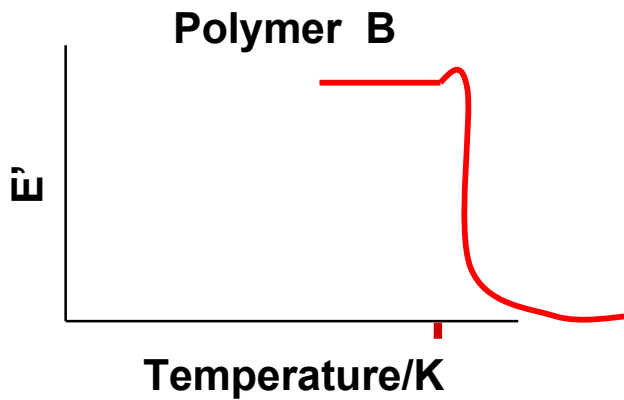

Block Copolymers
 Graft Copolymers
 Immiscible Blends

Random
 Copolymers &
 Miscible Blends

The frequency-dependence of dynamic experiments

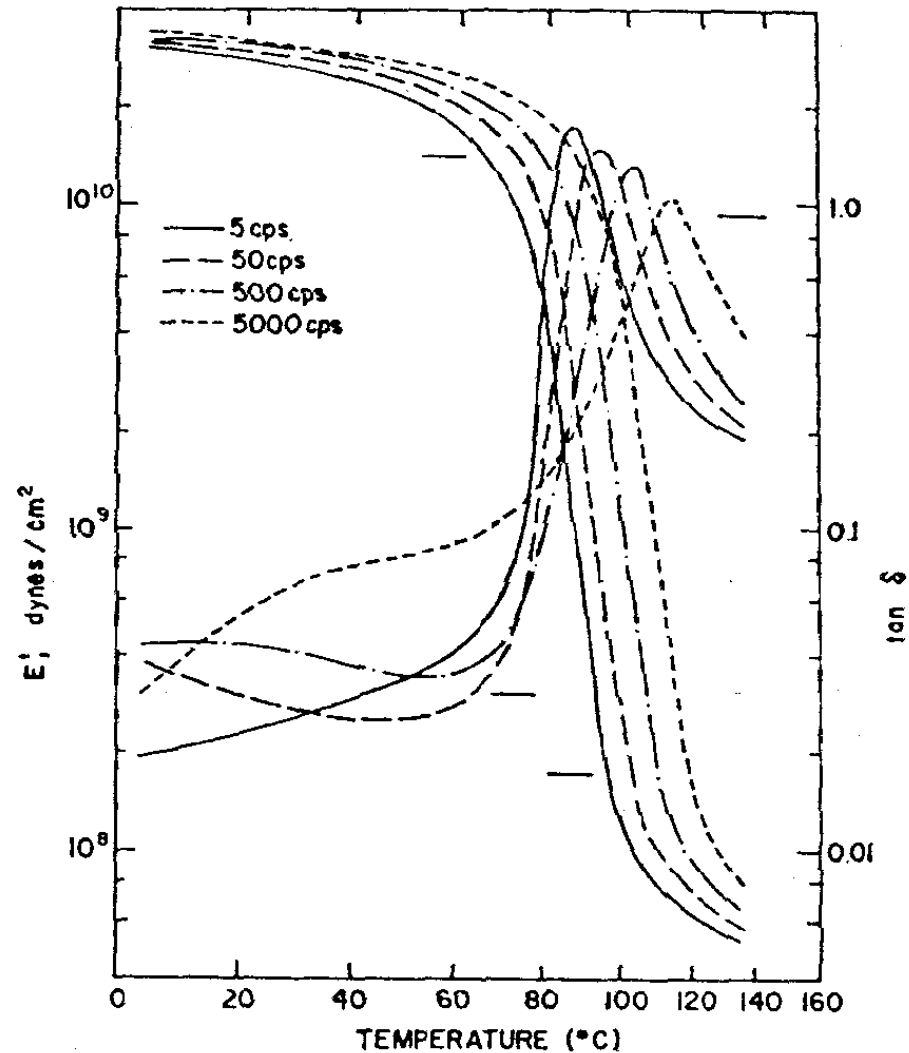

Temperature dependency of E' and $\tan \delta$ of PVC at different frequencies, after Becker, Kolloid-Z.140 (1955) 1

Time-Temperature-Superposition Principle

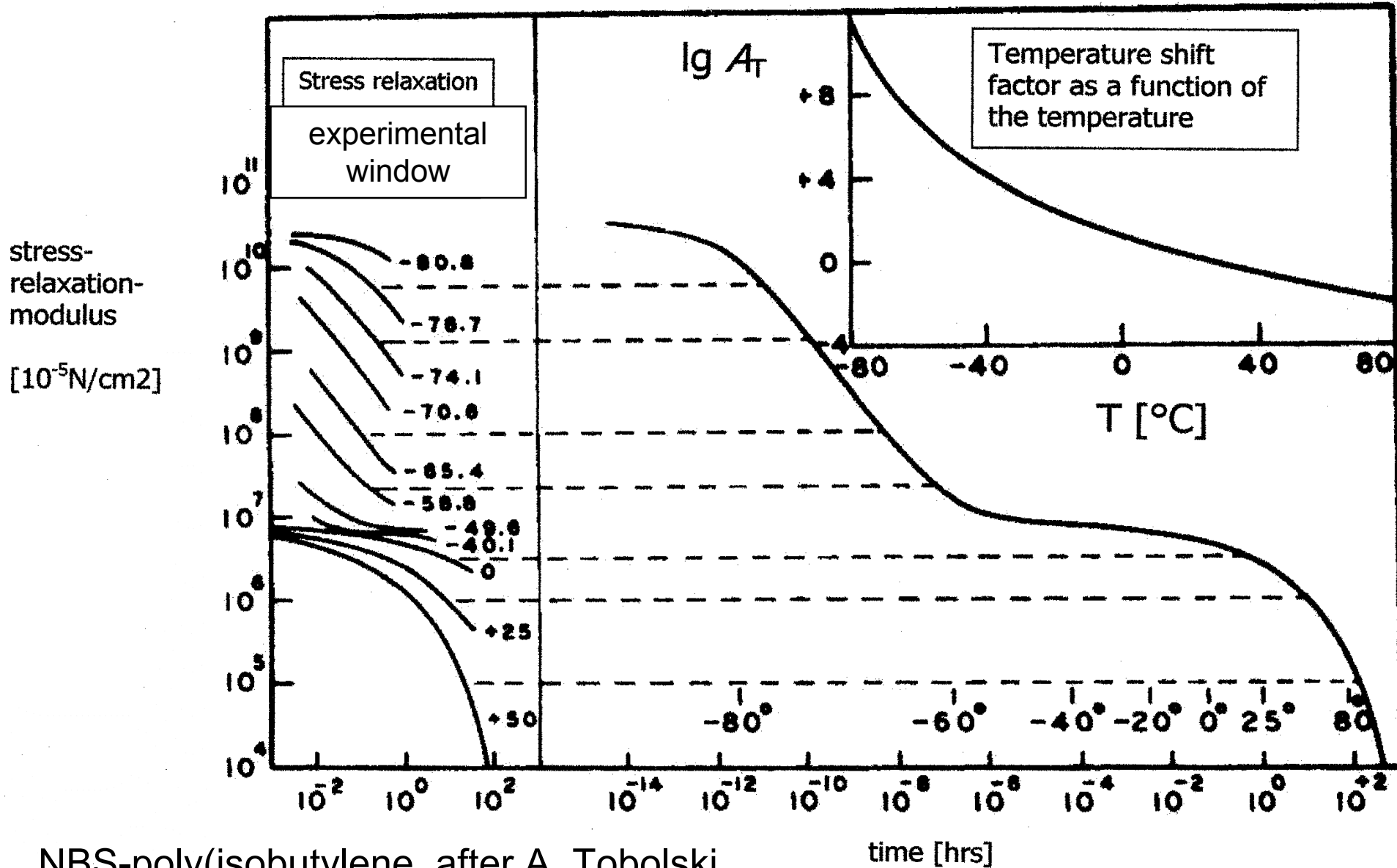

The glass transition temperature seen by viscosity

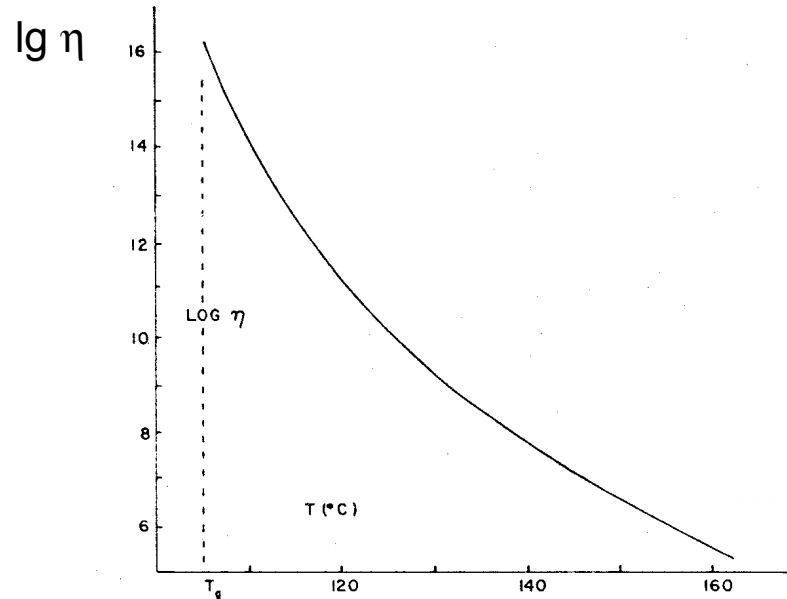

Temperature-dependence of the viscosity of PMMA (M=63.000 g/mol) after Bueche

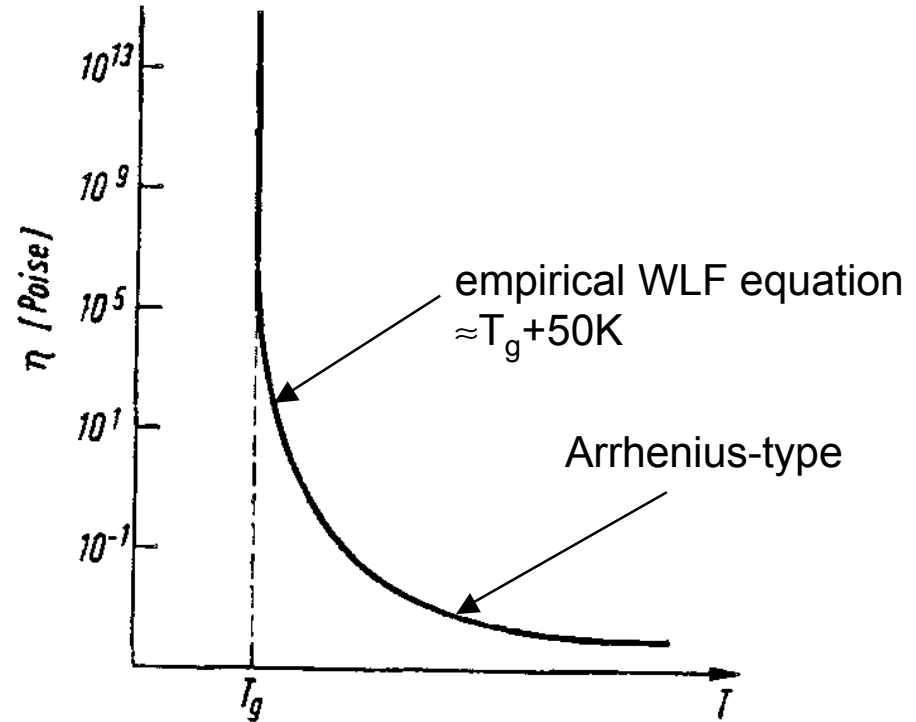

Williams-Landel-Ferry (WLF) equation

$$\ln \frac{\eta(T_s)}{\eta(T)} = \ln a_T = \frac{20,4(T - T_s)}{102 + T - T_s}; \quad T_s = (T_g + 50)K$$

TTS gives the frequency-dependence
of the glass transition temperature:

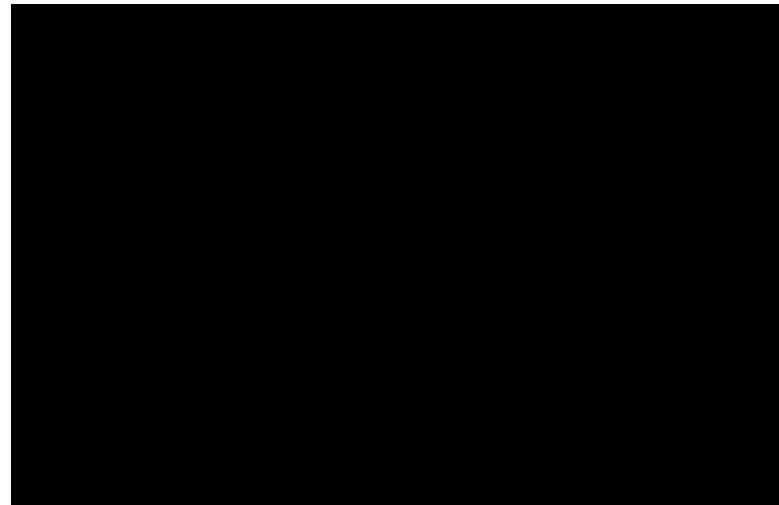

An increase of the measuring frequency (heating rate) by a factor 10 (or a decrease of the time frame by a factor of 10) near T_g the glass-transition temperature is found about 3 K higher.

Master Curves^{*)} extend the range

- We can collect data from 0.01 to 100 Hz.
- If we do this at many temperatures, we can “superposition” the data.

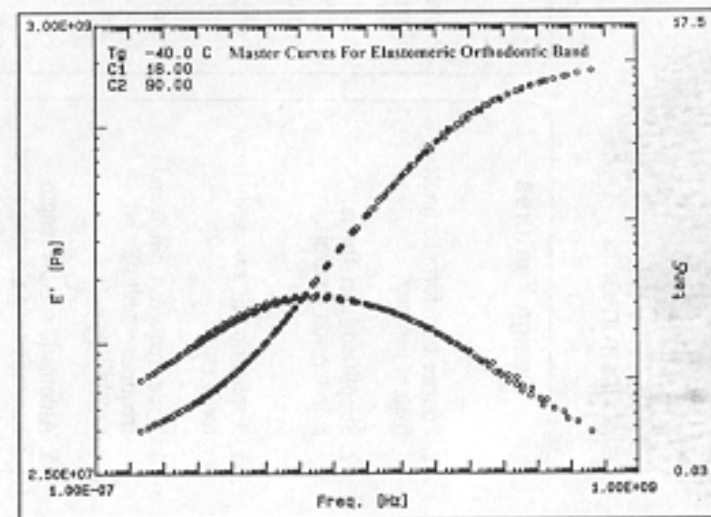
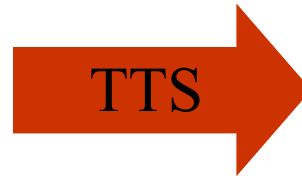
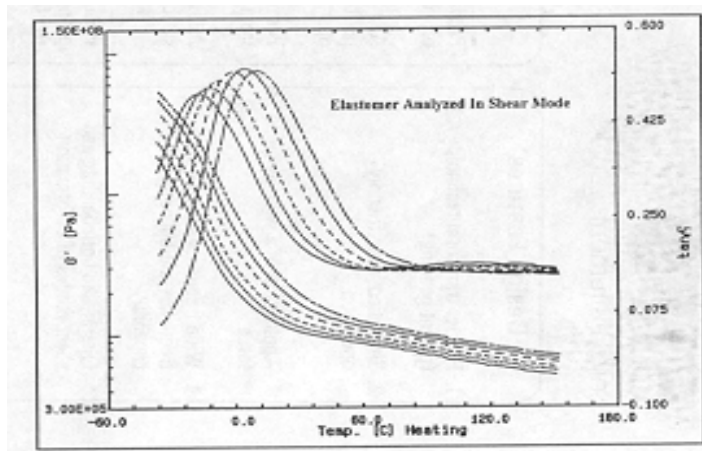

- After TTS, our range is $1e-7$ to $1e9$ Hertz (1/sec)
- Then x scale (frequency) can then be inverted to get time

^{*)} modulus or compliance; compliance = (modulus)⁻¹

BUT...

TTS assumes that:

“all relaxation times are equally affected by temperature.”

**THIS IS KNOWN TO OFTEN BE
INVALID.**

J. Dealy

Failure of TTS

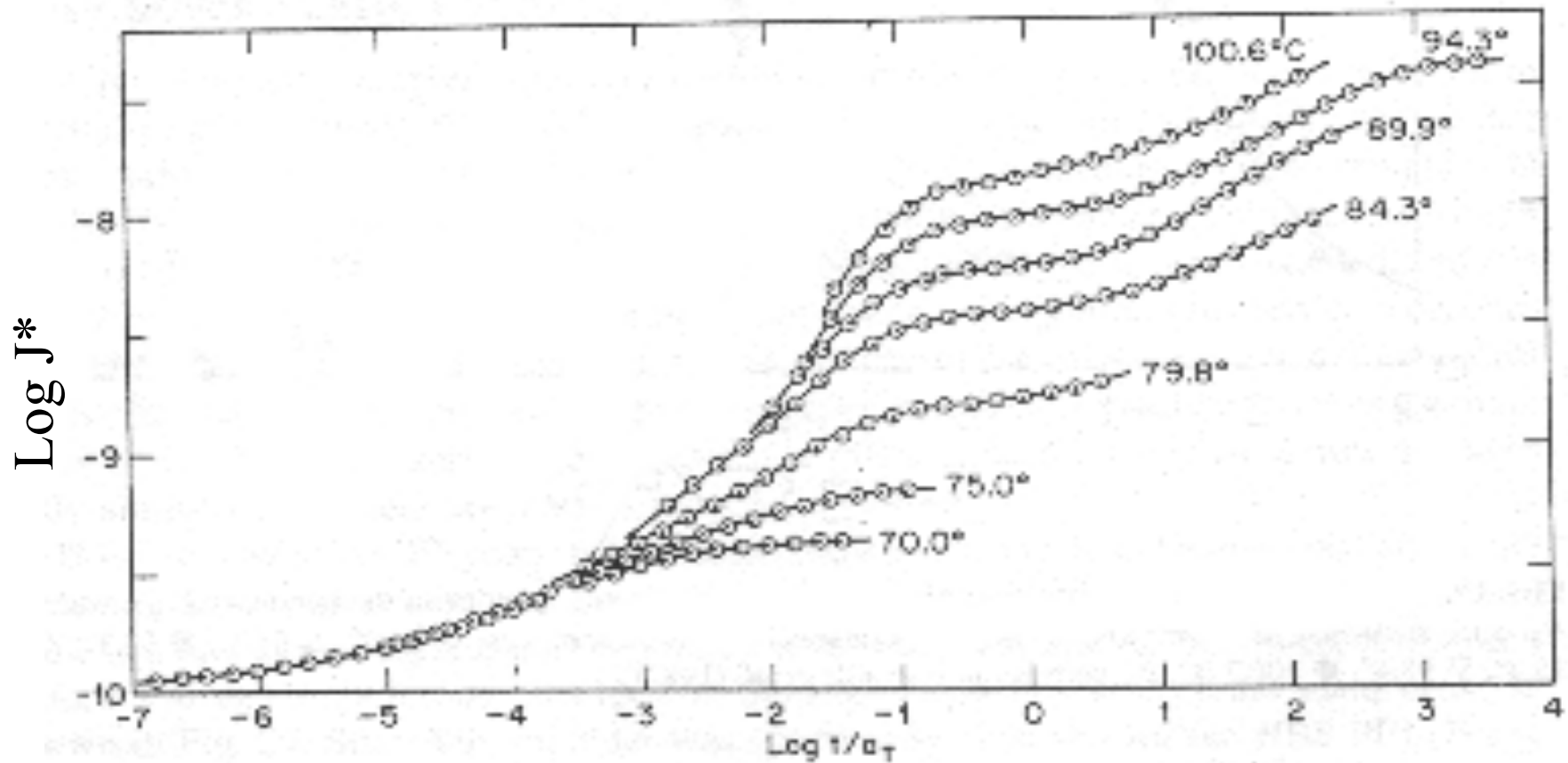

compliance $J = 1/E$

Analysis of a Cure by DMA

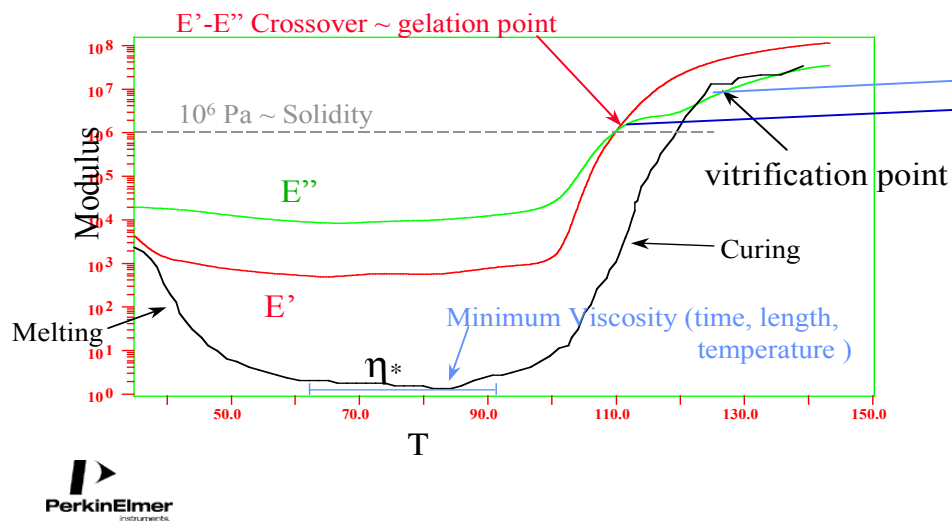

experiment at a constant heating rate

time-temperature-transition diagram after Gillham

Activation Energy tells us about the molecule

- For example, are these 2 T_g s or a T_g and a T_β ?

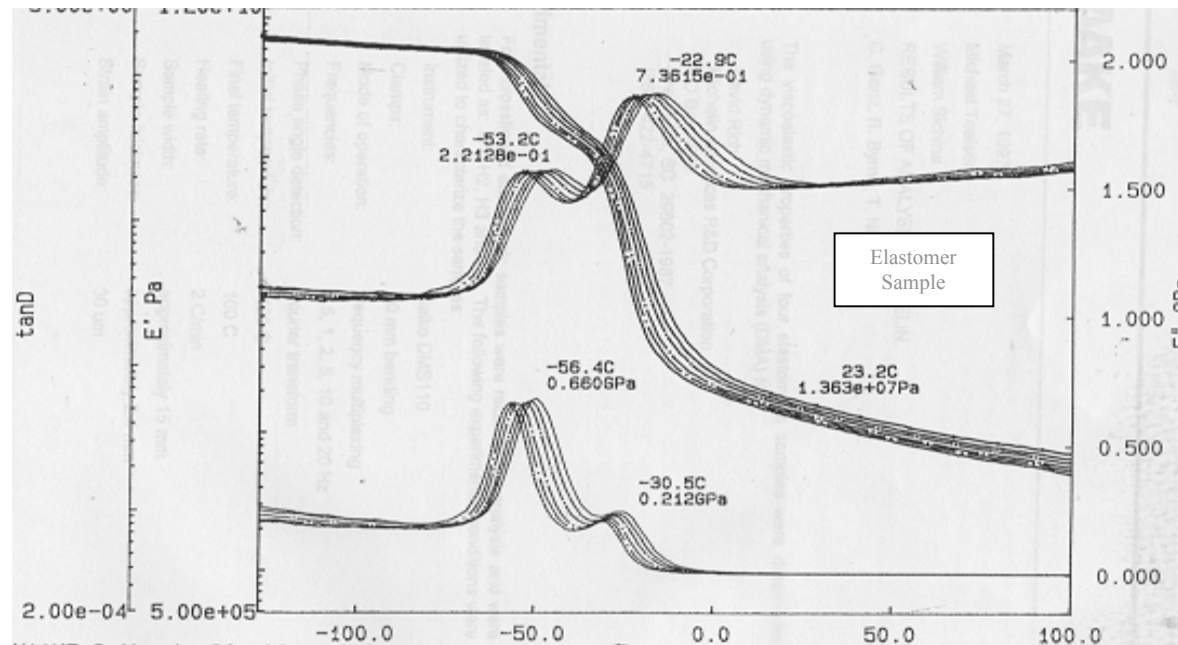

- Because we can calculate the E_{act} for the peaks, we can determine if both are glass transitions.

Determination of the apparent energy of activation

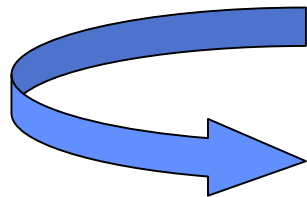
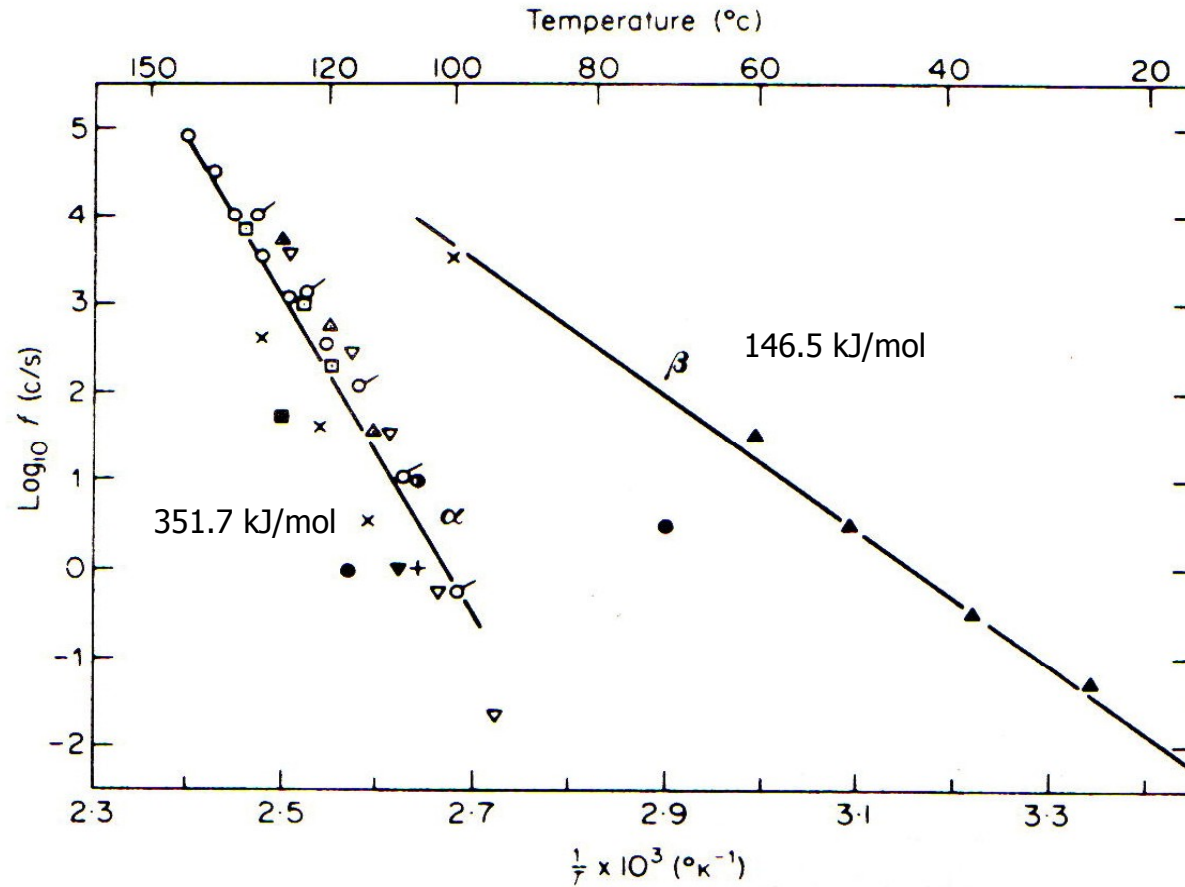

How can we do this experimentally??

MULTIPLEXING

Multiplexing...

Instead of just the T_g

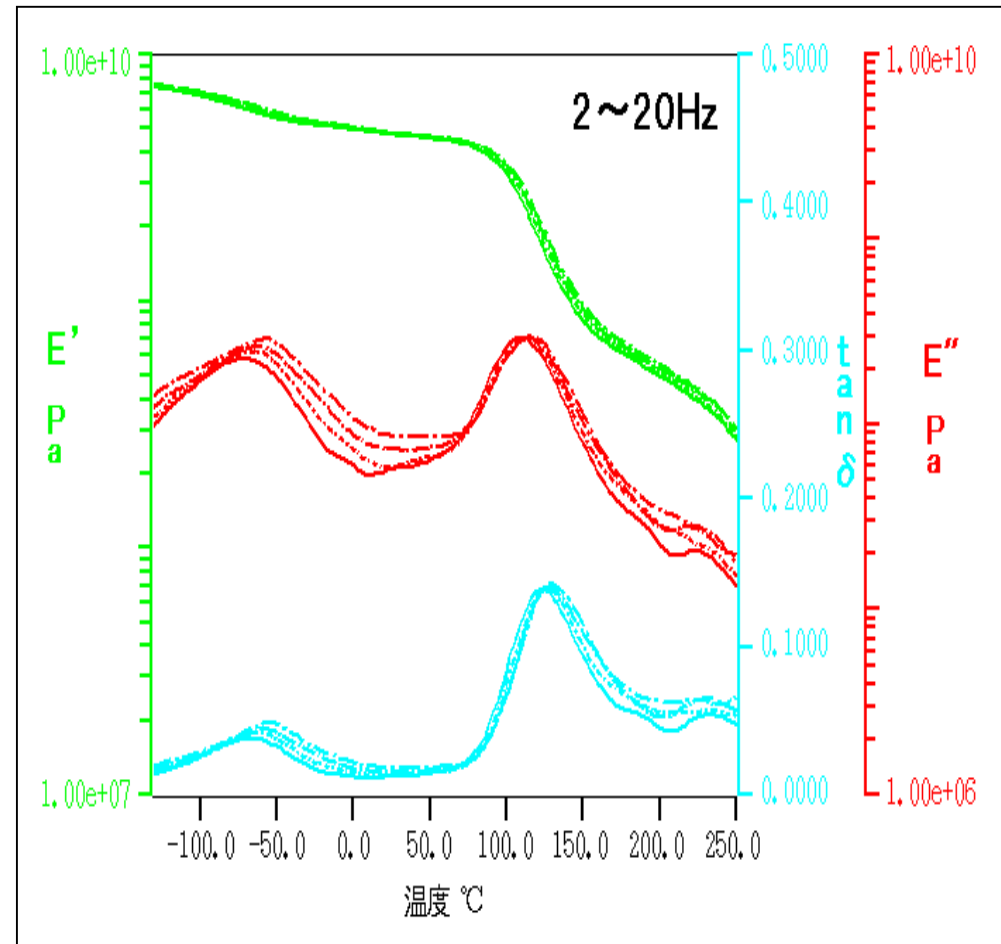
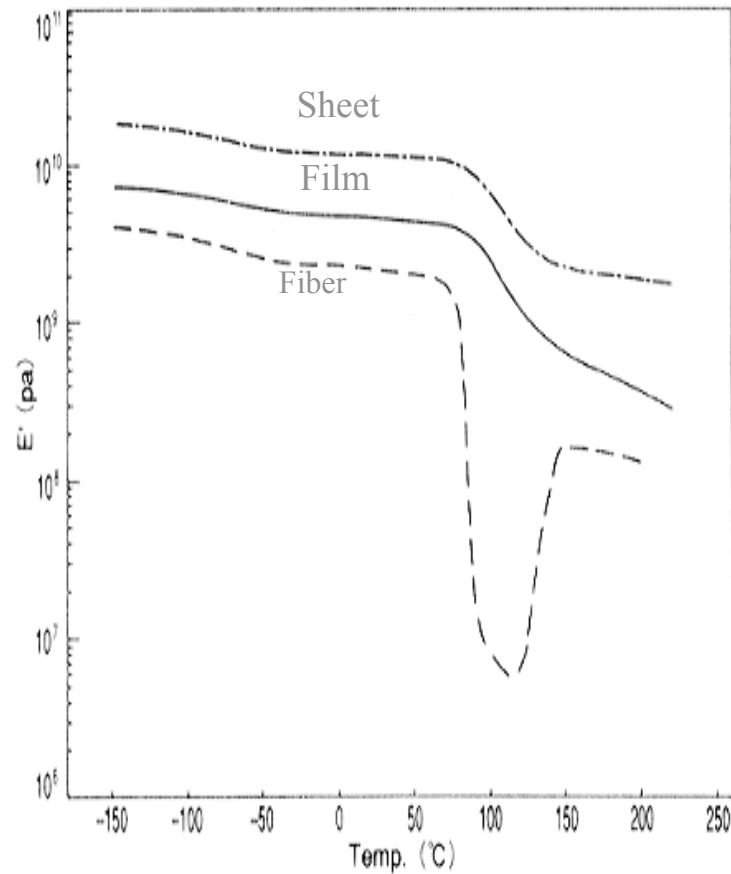

multiple frequencies in one run

Or you can use the Synthetic Oscillation Mode

Take five frequencies

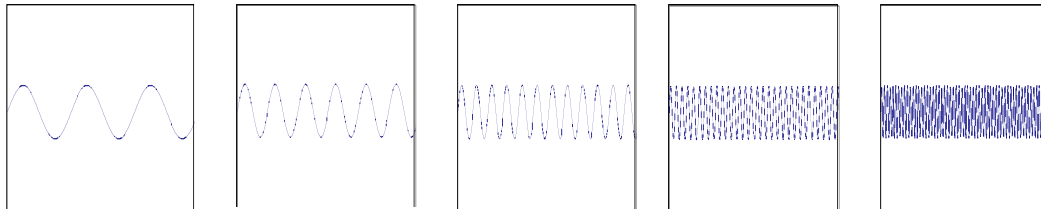

Sum together

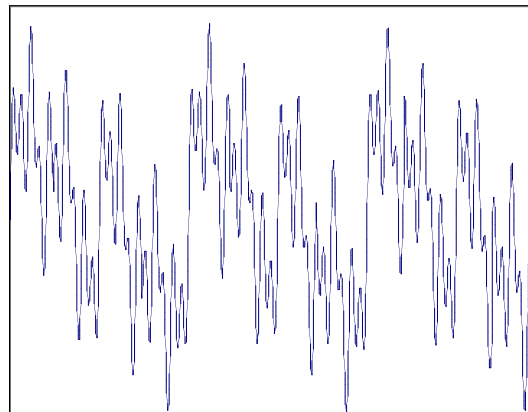

And apply
the
complex
wave form
to the
sample

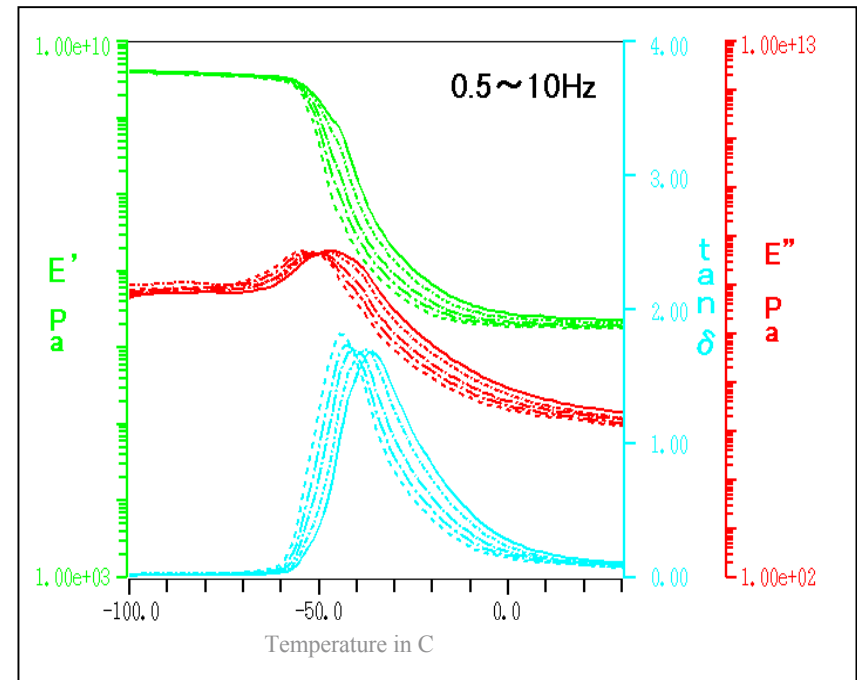

Gelation Point by Multiplexing

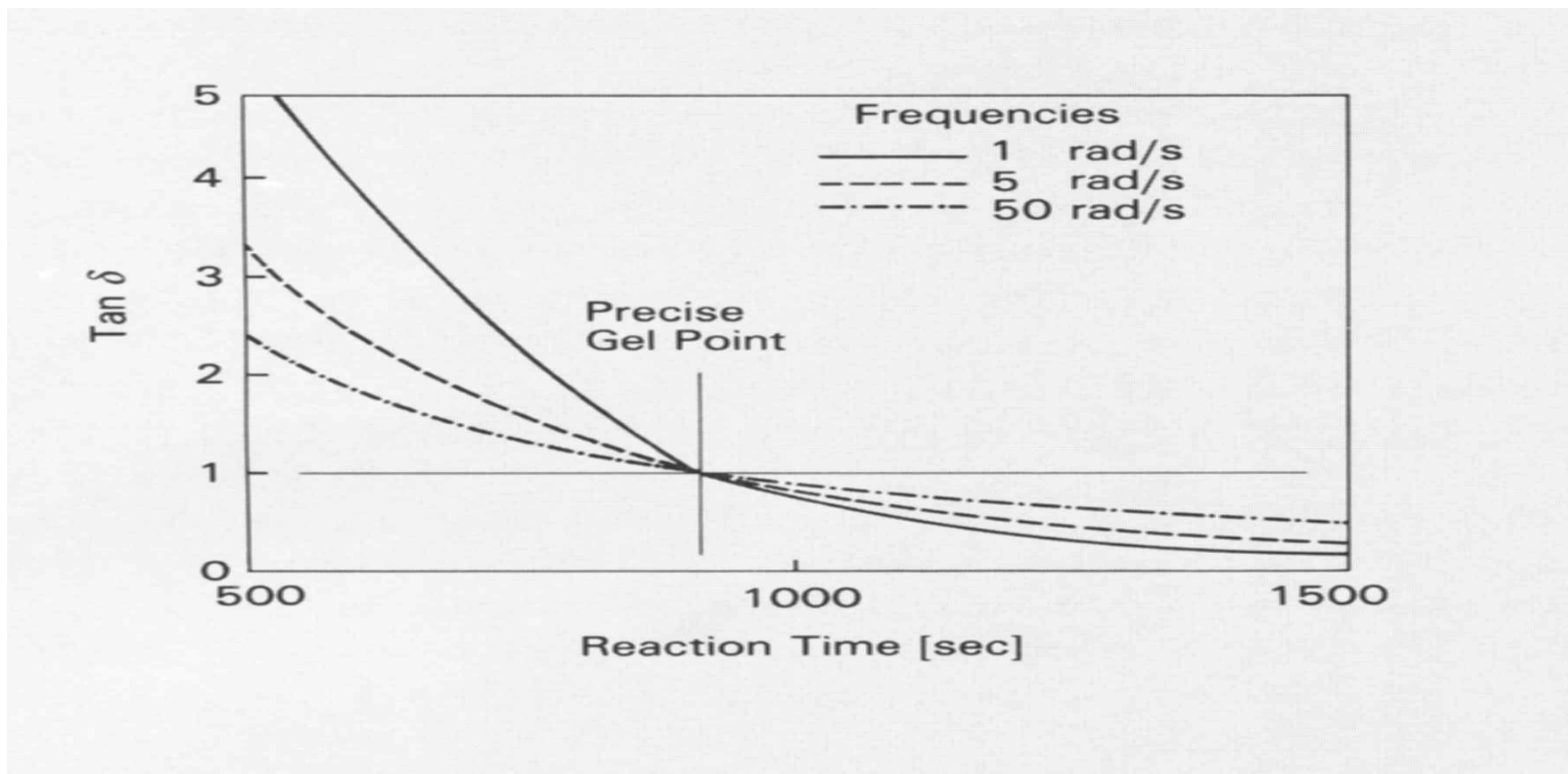

We can then do further analysis

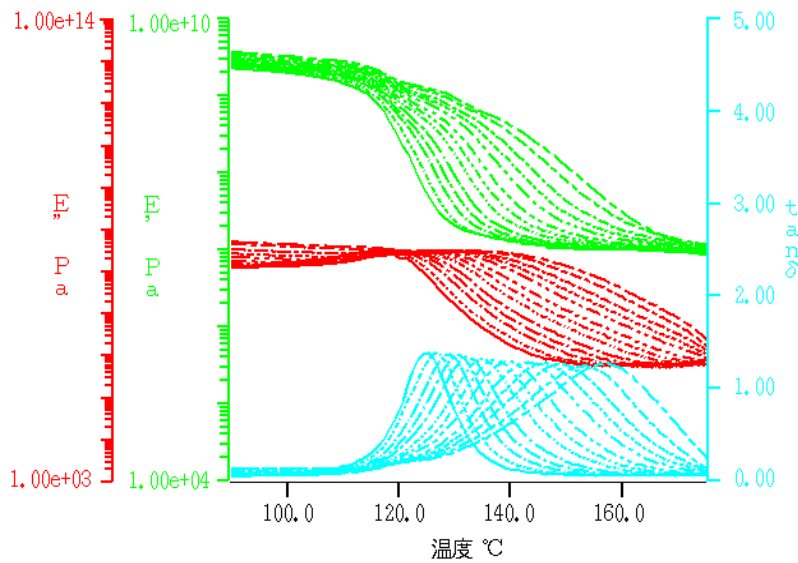

PMMA (0.01 ~ 100Hz)

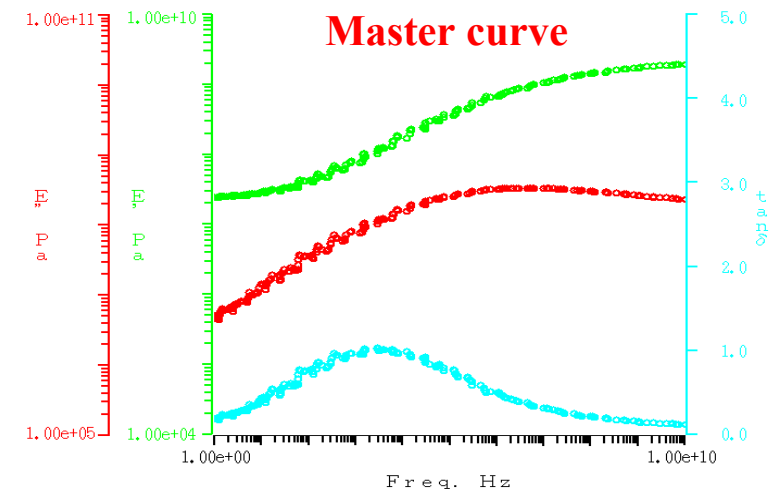
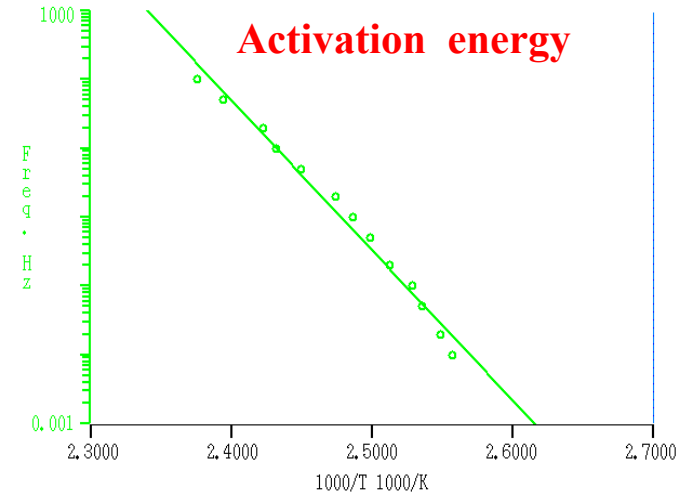
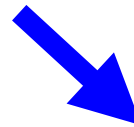

To Review, DMA ties together...

molecular structure

Molecular weight
MW Distribution
Chain Branching
Cross linking
Entanglements
Phases
Crystallinity
Free Volume
Localized motion
Relaxation Mechanisms

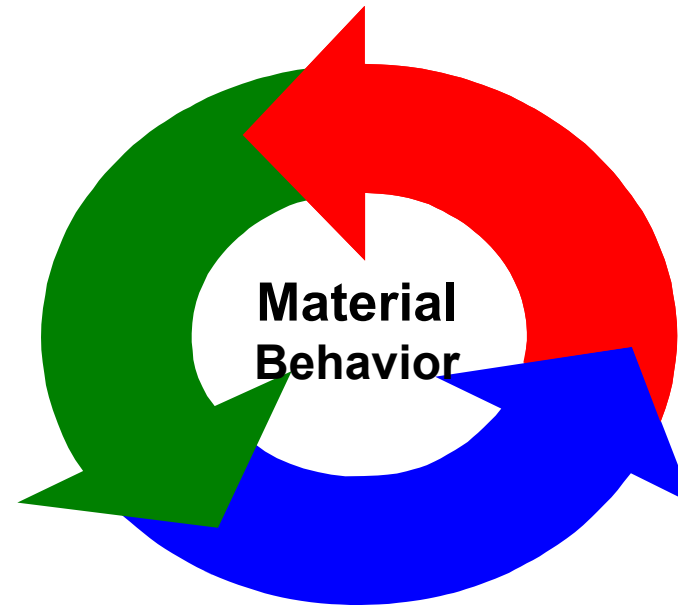

product properties

Dimensional Stability
Impact properties
Long term behavior
Environmental resistance
Temperature performance
Adhesion
Tack
Peel

processing conditions

Stress
Strain
Temperature
Heat History
Frequency
Pressure
Heat set

Further Reading

- Kevin P. Menard**, Dynamic-Mechanical Analysis, CRC-Press (1999) Boca Raton
- W. Brostow**, Performance of Plastics, Carl Hanser Verlag (2000) Munich
- I. M. Ward**, Mechanical Properties of Solid Polymers, Wiley (1983) New York
- J. J. Aklonis, W. J. McKnight**, Introduction to Polymer Viscoelasticity, Wiley-Interscience (1983) New York
- N. W. Tschoegl**, The Theory of Viscoelastic Behaviour, Acad. Press (1981) New York
- D. Ferry**, Viscoelastic Properties of Polymers, Wiley (1980) New York
- B. E. Read, G. D. Dean**, The Determination of Dynamic Properties of Polymers and Composites, Hilger (1978) Bristol
- L. E. Nielsen**, Polymer Rheology, Dekker (1977) New York
- L. E. Nielsen**, Mechanical Properties of Polymers, Dekker (1974) New York
- L. E. Nielsen**, Mechanical Properties of Polymers and Composites Vol. I & II, Dekker (1974) New York
- A. V. Tobolsky**, Properties and Structure of Polymers, Wiley (1960) New York

Many examples by courtesy of Kevin Menard
(University of North Texas, Department of Materials Science
and Perkin Elmer Corp.)