

The Differential Viscometer. II. On-Line Viscosity Detector for Size-Exclusion Chromatography

MAX A. HANEY, *Viscotek Corporation, 1030 Russell Dr.,
Porter, Texas 77365*

Synopsis

The new technique of differential viscometry measures directly the specific viscosity of a solution by subtracting the contribution of solvent in a balanced capillary bridge. The present work adapts the differential viscometry principle to the design of a viscosity detector for use in size-exclusion chromatography. It is shown that the resulting viscosity detector possesses excellent sensitivity and baseline stability with a minimum detectable specific viscosity of 2.7×10^{-5} . The viscosity detector can be operated together with a refractive index detector to determine the intrinsic viscosity of polymer solute fractions as they elute from the SEC column. The bandspreading of the viscosity detector is compared to the refractive index detector by measuring the peak width of a compound having a single discrete molecular weight. The peak width at half-height was 0.29 mL for the viscosity detector and 0.25 mL for the refractive index detector.

INTRODUCTION

Size-exclusion chromatography (SEC) is the most widely used technique for determining molecular weight distribution of polymers. A persistent problem in SEC is the difficulty of calibration. Conventional calibration methods use a series of narrow distribution polymer standards or in some cases a broad distribution polymer standard. The difficulty arises from the fact that reliable standards are available for only a very few polymer materials. Standards of one polymer type do not work for any other polymer type. The calibration problem is so intractable that molecular weight values obtained by SEC are used mostly for comparative purposes among polymers of the same composition. This severely limits the applications, because in many cases it is desired to compare molecular weights of different polymers in order to separate the effects of molecular weight and molecular structure on polymer properties.

One way around the calibration problem is to use a low-angle laser light scattering (LALLS) detector in conjunction with the concentration detector.¹ The LALLS detector produces a signal which is a function of the molecular weight of the polymer solute. No molecular weight standards are needed, but the refractive index increment dn/dc and the second virial coefficient A_2 for the particular polymer-solvent system must be known or determined separately.

The Universal Calibration Method has long been considered to be potentially the ideal solution to the problem. This method is based on the concept of the hydrodynamic volume $[\eta]M$ being the determining factor in the size-exclusion retention mechanism. A plot of $[\eta]M$ vs. retention volume should

then be invariate for a given column set, independent of polymer structure. The validity of universal calibration has been confirmed experimentally on a variety of polymer solvent systems. Benoit et al.² first showed its validity with flexibly coiled, organic-soluble polymers of the type used in thermo-plastic applications. Fish et al.³ demonstrated it for complex proteins and denatured proteins. Frigon et al.⁴ found it valid for dextrans and globular proteins. Many exceptions to universal calibration have been found, but these are generally ascribed to the interference of nonexclusion mechanisms on the retention. In fact, proportionality of retention volume to $[\eta]M$ is now generally taken as a test of the operability of the size-exclusion mechanism.

It is obvious that a viscosity detector is needed in order to fully utilize the universal calibration method. However, most applications to date have not used a viscosity detector because of the unavailability of commercial units. Several attempts have been made to construct viscosity detectors based on the principle of measuring the pressure drop produced by the SEC effluent flowing through a single capillary tube.⁵⁻⁷ These devices have succeeded in showing the utility of a viscosity detector, but they have not evolved into commercial instruments because of a lack of sensitivity and stable baseline. The root cause of this insensitivity and instability is evident: The baseline pressure due to the solvent is only slightly less than the peak pressure due to the SEC effluent. Clearly a method is needed which effectively subtracts the baseline pressure, e.g., a differential measurement.

The differential viscometer (DV) previously described⁸ functions in this manner, providing high sensitivity for specific viscosity measurements of solutions. It will be shown in this paper that a slight rearrangement of the basic capillary bridge system converts the DV into a viscosity detector for SEC. The DV detector nulls the solvent pressure as desired, yielding a differential signal proportional to the specific viscosity of the SEC effluent. It is somewhat analogous to a differential refractometer detector which yields a differential signal proportional to concentration. The two detectors together provide measurement of the intrinsic viscosity η_{sp}/C .

INSTRUMENTATION

Principles

A simplified schematic of the SEC viscosity detector is shown in Figure 1. The SEC effluent flows continuously through the bridge network, which consists of four capillaries R_1 - R_4 of equal flow resistances. It differs in basic design from the DV of Ref. 8 in that one of the holdup reservoirs (A) has been relocated to a position out of the flow stream and now acts only as a compensation volume so that any temperature fluctuations cause equal volume changes on each side of the differential pressure transducer. The other reservoir holds up the SEC effluent and prevents it from entering capillary R_4 . Both reservoirs can be switched simultaneously either in or out of the bridge circuit by means of tandem switching valves S_A - S_B . When they are out of the circuit (BYPASS position), they can be filled with mobile phase solvent by means of a pumping system not shown.

When valves S_A - S_B are turned to INJECT position the SEC effluent flows

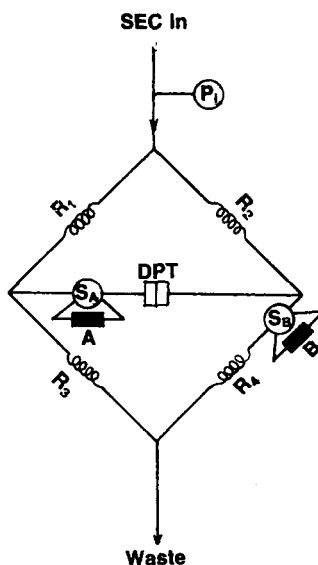

Fig. 1. Simplified schematic of DV detector.

into reservoir B, displacing the solvent. For any time slice in the chromatogram polymer solution will be in capillaries R_1 , R_2 , and R_3 , but solvent will be in capillary R_4 . Obviously, reservoirs A and B must be large enough that the solvent is not entirely displaced until after the chromatographic peak is completely eluted.

The action of the reservoir is illustrated in Figure 2, which shows a chromatogram obtained on the DV detector. The differential pressure baseline is constant until some point after the elution of the peak where the volume of solvent in the holdup reservoir B is exhausted and breakthrough

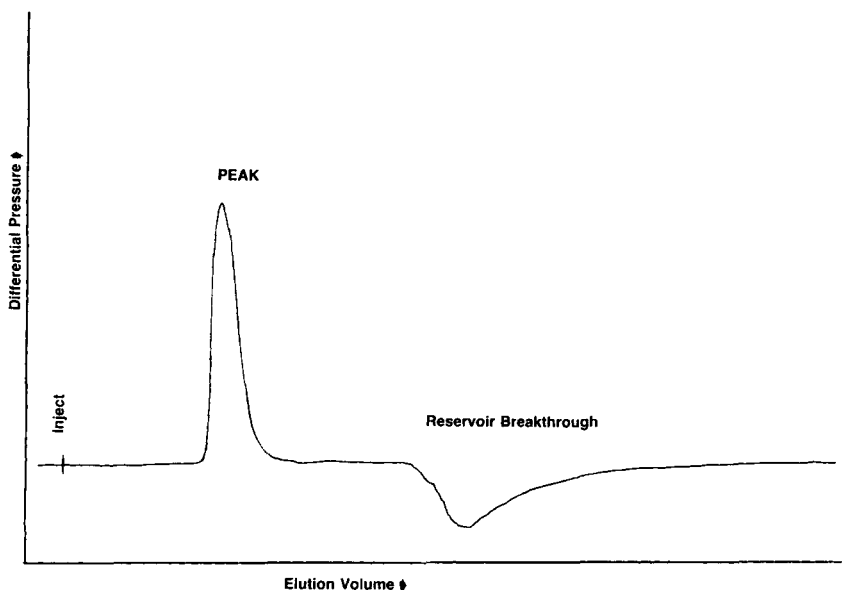

Fig. 2. DV chromatogram illustrating holdup action of reservoir.

of the polymer solution onto capillary R_4 occurs. There follows a broad negative peak as the holdup reservoir B is gradually purged by the mobile phase. The next injection can be made after the baseline is restored. A faster alternative is to switch the valve back to BYPASS position after the peak is eluted and use the gear pump to flush the holdup reservoir with fresh mobile phase solvent. The valve can then be switched back to INJECT position, and the baseline is quickly restored.

Calculation of Specific Viscosity

The measured quantities are bridge inlet pressure P_i , measured with respect to the outlet, and the differential pressure at any point in time ΔP .

$$\frac{\Delta P}{P_i} = \frac{P_2 - P_1}{P_i} \quad (1)$$

where P_1 is the pressure drop across R_3 and P_2 is the pressure drop across R_4 . Since the same solution is flowing through equal flow resistances R_1 and R_3 , $P_1 = 2P_3$:

$$\frac{\Delta P}{P_i} = \frac{1}{2} \left(\frac{P_2}{P_1} - 1 \right) \quad (2)$$

Applying Poiseuille's law to R_3 and R_4 ,

$$\frac{P_2}{P_1} = \frac{\eta_0 Q_2}{\eta Q_1} \quad (3)$$

where Q_1 is the flow rate through R_1 , R_3 , Q_2 is the flow rate through R_2 , R_4 , η is the viscosity of the solution, and η_0 is the viscosity of the solvent. The ratio of flow rates Q_2/Q_1 is equal to the inverse ratio of the total resistance in each side of the bridge:

$$\frac{Q_2}{Q_1} = \frac{\eta + \eta_0}{\eta + \eta_0} = \frac{2\eta}{\eta + \eta_0} \quad (4)$$

Combining eqs. (2)–(4) yields

$$\frac{\Delta P}{P_i} = \frac{1}{2} \left(\frac{\eta - \eta_0}{\eta + \eta_0} \right) \quad (5)$$

Inserting the definition of specific viscosity in eq. (5) yields

$$\frac{\Delta P}{P_i} = \frac{\eta_{sp}}{2\eta_{sp} + 4} \quad (6)$$

which may be rearranged to

$$\eta_{sp} = \frac{4\Delta P}{P_i - 2\Delta P} \quad (7)$$

Equation (7) is an exact equation subject to the following assumptions:

—The capillaries have equal flow resistances. This condition can be obtained by trial and error to any desired degree of accuracy.

—The flow is in accord with Poiseuille's law. This law is typically valid for low flow rates and larger L/D ratios of the capillaries.

Design and Construction

A plumbing schematic of the viscosity detector is shown in Figure 3. Construction is the same as for the viscometer configuration of Ref. 8, except for the capillaries and reservoirs. For the present experiments the capillaries are made of coiled stainless steel tubing 0.010 in. ID \times 0.0625 in. OD, approximately 30 in. L. The reservoirs are made of coiled stainless steel tubing 0.125 in. OD \times 0.107 in. ID \times 5 ft L with internal volume of 8 mL.

Connection to SEC

The viscosity detector must be used in conjunction with a concentration detector such as a refractive index detector (RID). In principle, the viscosity

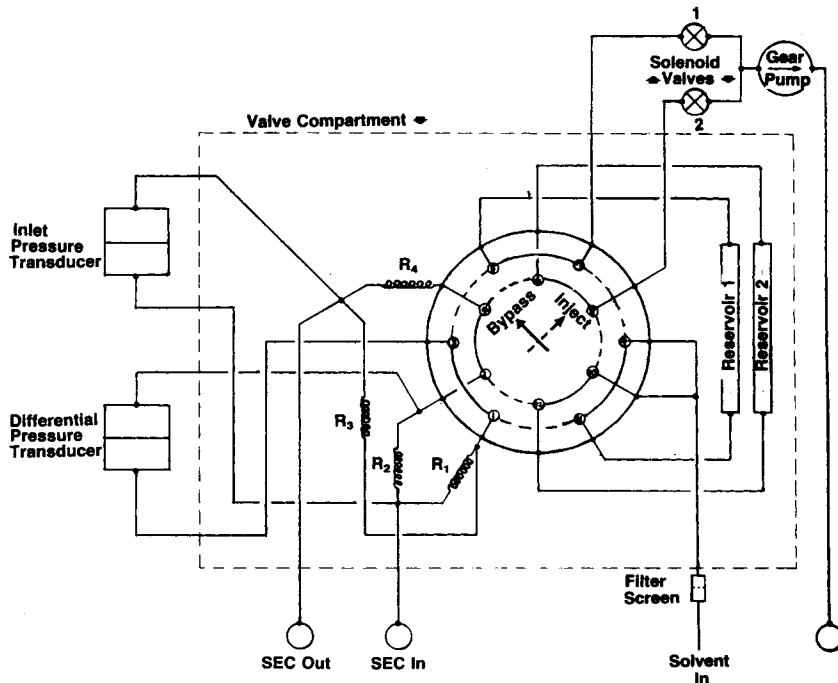

Fig. 3. Detailed plumbing schematic of DV detector.

detector can be connected in three different positions with respect to the RID. Each of these configurations presents particular problems.

DV before RID. The basic problem here is that the SEC effluent is diluted by a factor of 2 as it passes through the viscosity detector.

DV after RID. The viscosity detector presents a back pressure on the RID cell, which, if it becomes excessive, could break the cell. Also, most RID units have large bore tubing on the outlet. This will cause excessive bandspreading in the DV chromatogram.

Parallel. The flow resistance of each detector including correcting lines should be approximately equal, although it is not strictly necessary. This will require some adjustment of the length of connecting tubing to the two detectors.

It can be seen that the parallel configuration is generally more advantageous. The data reported here were obtained with this configuration. A block diagram of the SEC system is shown in Figure 4. The pneumatic pulse dampener shown is a coil of teflon tubing 0.125 in. OD \times 18 in. L sealed at the end and filled initially with air. When the flow is turned on the solvent pushes partly into the tubing, reaching an equilibrium static pressure. This simple pneumatic dampener has been found to be adequate for the present experiments. For long term service the pump should be dampened directly.

Chromatographic Conditions

Refractive index detector, DuPont; columns, 1 pair of DuPont PSM bimodals; mobile phase, tetrahydrofuran; flow rate, 1.5 mL/min; temperature, ambient; injection volume, 50 μ L.

RESULTS AND DISCUSSION

The advantage of the balanced bridge concept is dramatically illustrated in Figure 5, which shows a chromatogram of NBS 706 polystyrene standard while monitoring the differential pressure ΔP and the inlet pressure P_i simultaneously on the strip chart recorder. Figure 5(a) shows the chromatogram with the pulse dampener removed. The pulsations due to the pump are clearly visible in both the inlet pressure and the differential pressure traces. Note, however, that the pulsation noise on the ΔP trace is

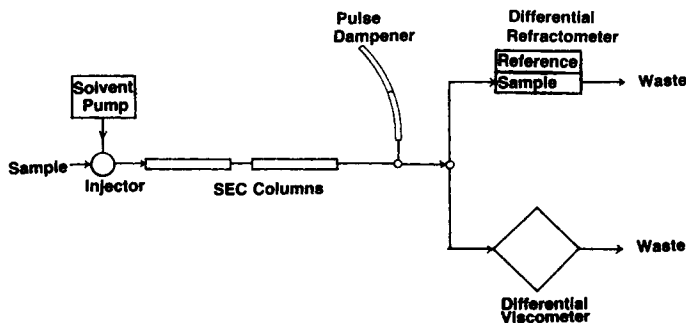

Fig. 4. Block diagram of SEC system including DV detector.

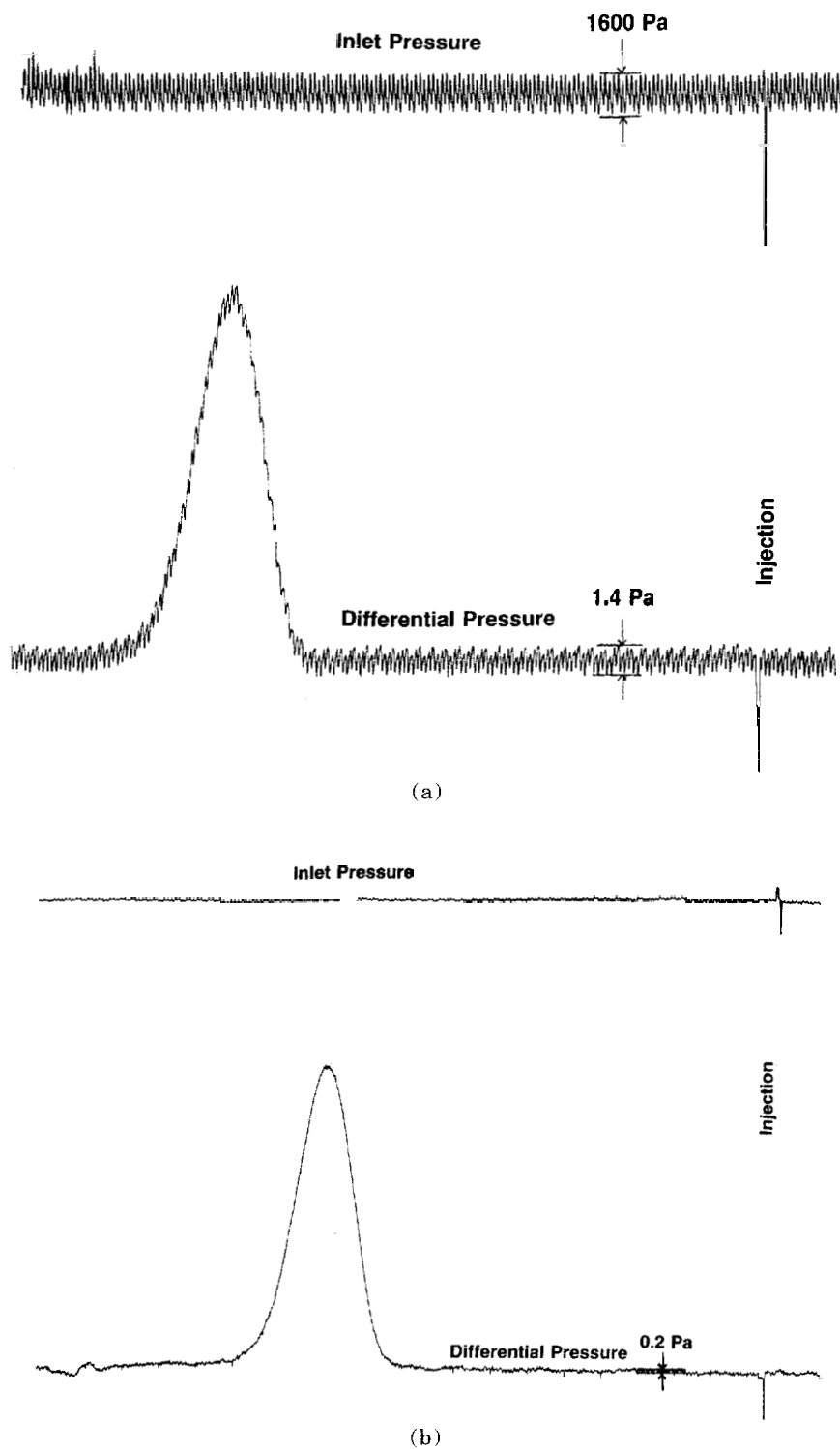

Fig. 5. DV chromatogram of polystyrene sample NBS 706: (a) no pulse dampening; (b) pulse dampened.

more than 1000 times lower than the pulsation noise on the inlet pressure trace. This large reduction is due to the cancelling of the flow pulsations on each side of the bridge. It vividly illustrates the advantage of the balanced bridge approach over the single capillary viscometer. In Figure 5(b) the pulse dampener has been added, and now the pulsations are barely visible on the inlet pressure and are buried in the random noise of the differential pressure. The random noise (p-p) of the ΔP is 0.2 Pa, which together with the measured P_i of 30.6 kPa yields a specific viscosity of 2.7×10^{-5} from eq. (7). This noise level is approximately equal to the inherent noise of the differential pressure transducer so that 2.7×10^{-5} can be taken as the minimum detectable specific viscosity. Figure 6 is a dual chromatogram of the polystyrene standard using both the DV detector and the RI detector connected in parallel. The amount of sample injected is only 25 μg , but the DV peak shows ample sensitivity, even better than the RI peak. The weight-average molecular weight of this sample is about 250,000 and the number average molecular weight is about 115,000. Figure 7 is a dual chromatogram of a polyvinylchloride sample of unknown molecular weight. Observe that the S/N of the DV chromatogram is several times better than the RI chromatogram. Figure 8 is a dual chromatogram of a polybutadiene of molecular weight 3400. The S/N is comparable for the two detectors in this case. Figure 9 is a dual chromatogram of an epoxy resin of molecular weight 300–400. Now the S/N of the DV is considerably worse than the RI. Figure 10 is a dual chromatogram of a polymer additive, Irganox 1010, which has a discrete molecular weight of 1120.

The bandspreading of the DV detector can be measured from the peak widths of Figure 10 since this compound has a single discrete molecular weight. The peak width at half height for the RI peak is 0.24 mL and for the DV peak it is 0.29 mL. The DV detector adds 0.05 mL additional bandspreading compared to the RI detector. The quantitative implications of

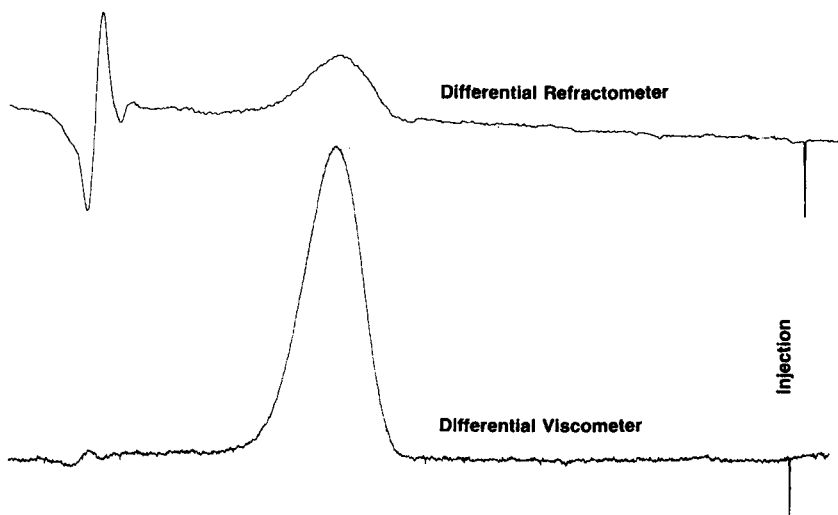

Fig. 6. Dual chromatogram of polystyrene sample NBS 706. Concentration injected = 0.5 mg/mL, volume = 0.05 mL.

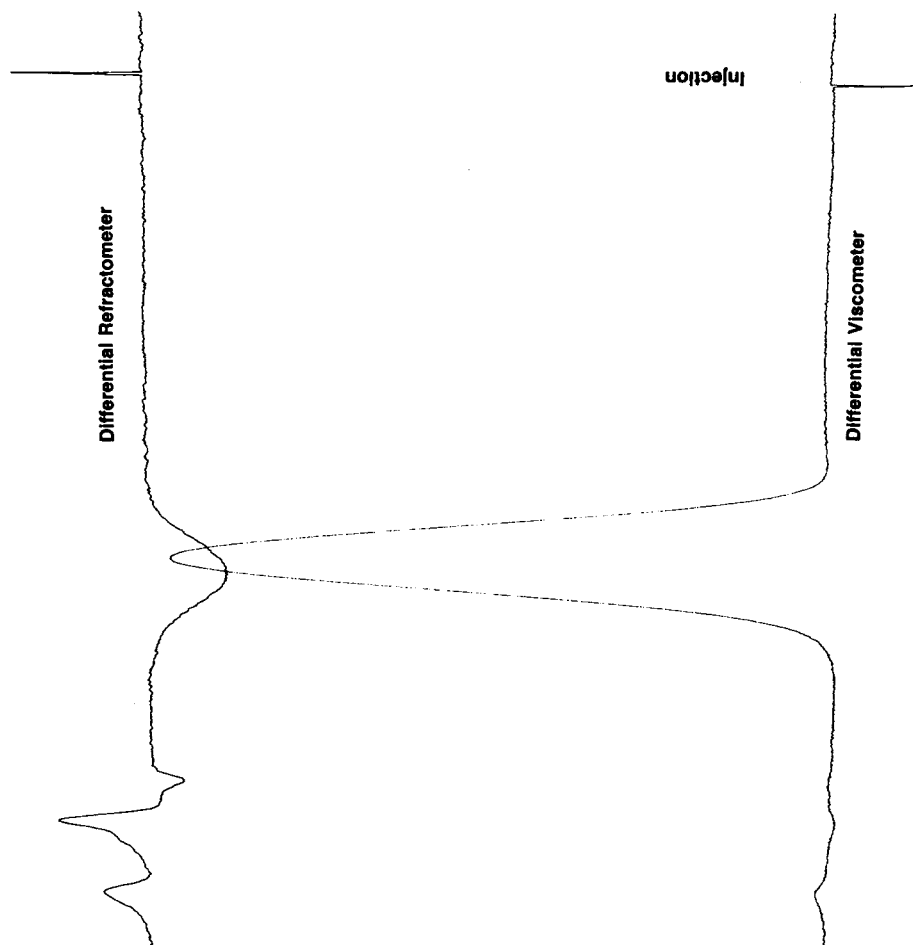

Fig. 7. Dual chromatogram of polyvinylchloride sample. Concentration injected = 1.1 mg/mL, volume = 0.05 mL.

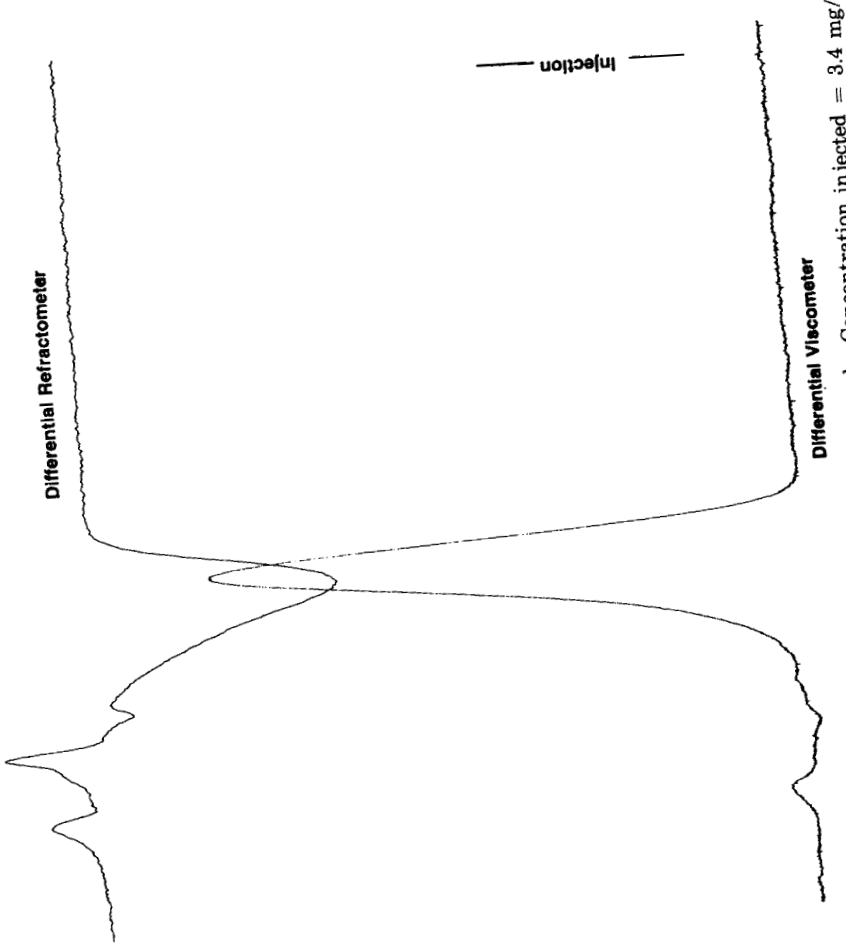

Fig. 8. Dual chromatogram of polybutadiene sample. Concentration injected = 3.4 mg/mL, volume = 0.05 mL.

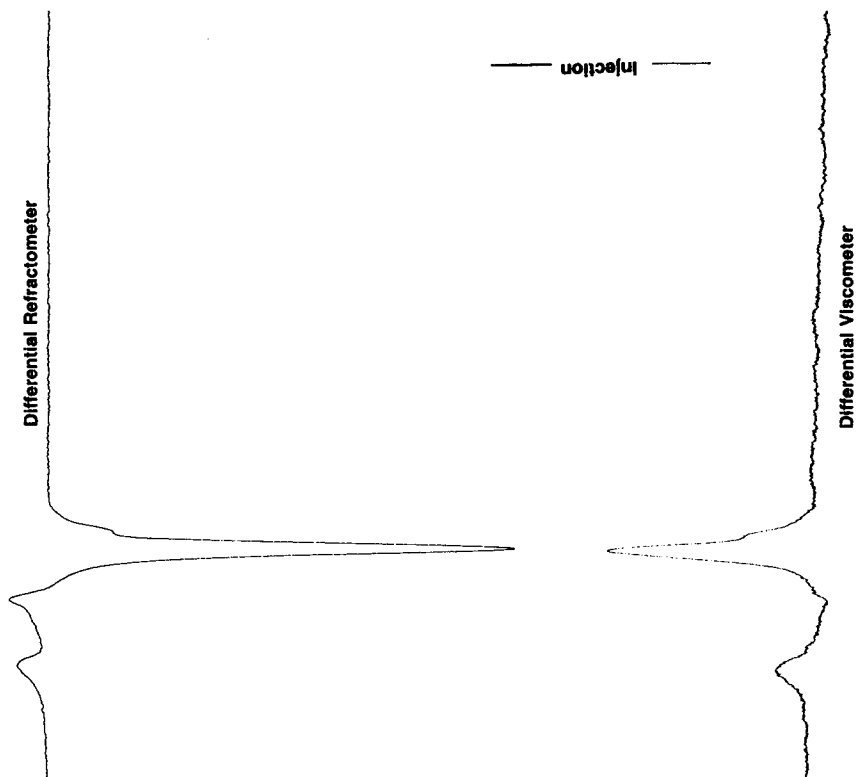

Fig. 9. Dual chromatogram of epoxy sample EPON 828. Concentration injected = 2.8 mg/mL, volume = 0.05 mL.

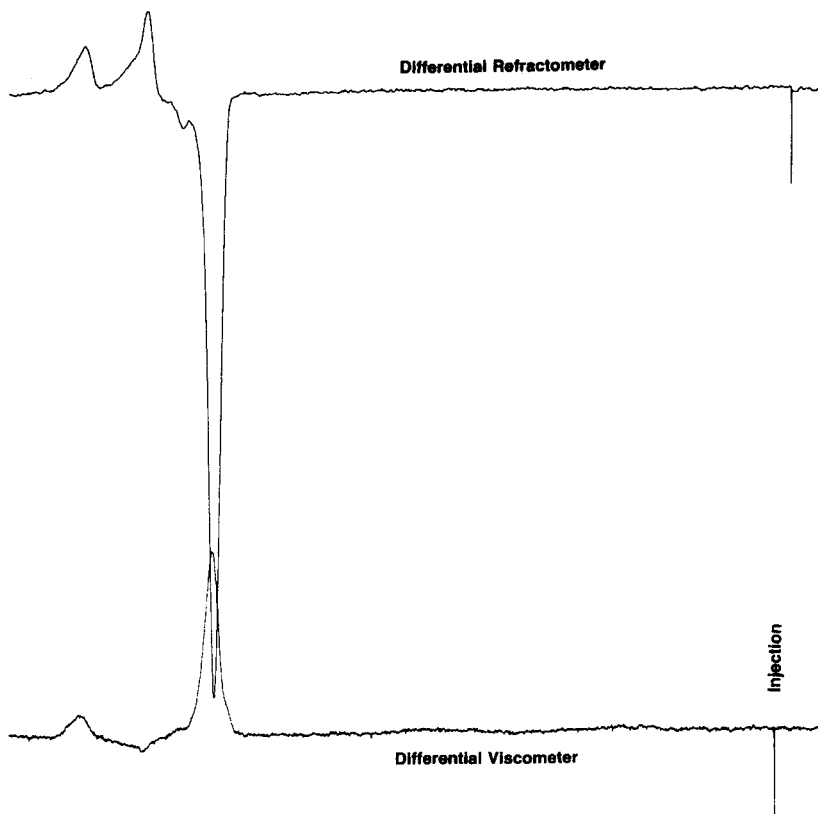

Fig. 10. Dual chromatogram of polymer antioxidant Irganox 1010. Concentration injected = 1.8 mg/mL, volume = 0.05 mL.

this bandspreading will be assessed in future work. Qualitatively, it does not appear to have much effect. Observe the high molecular weight shoulder on the epoxy chromatogram in Figure 9. The apparent resolution of the shoulder is about the same in both the RI and DV traces. Bandspreading can be decreased by using smaller capillary tubing in the DV, if this proves necessary. The primary application of the DV detector is for universal calibration, which is beyond the scope of the present paper. The quantitative application to universal calibration determination of molecular weight distributions will be investigated in subsequent publications. However, the DV detector is very similar to the differential viscometer of Ref. 8, which has been shown to yield excellent quantitative measurements of intrinsic viscosities.

The strong dependence of the sensitivity of the DV on molecular weight is expected, of course. The intrinsic viscosity of polymers is related to the molecular weight by the Mark-Houwink equation

$$[\eta] = KM^a \quad (8)$$

where K and a are empirically determined constants. The exponent a typically lies in the range of 0.5–0.8.

CONCLUSIONS

The application of the balanced bridge concept of differential viscometry to viscosity detection of SEC effluents yields sensitivity vastly superior to that obtained with single capillary viscometers. Sensitivity of the DV detector is a function of molecular weight, of course, being superior to that of an ordinary RI detector at molecular weights of only few thousand and above. Band broadening is not excessive within the resolution capabilities of typical SEC columns.

The excellent sensitivity and adequate resolution obtained with the DV should make it a practical detector for use in the universal calibration method. However, it is to be noted that its utility is not limited to the universal calibration method. When used in SEC in combination with a concentration detector it will measure the intrinsic viscosity distribution of any polymer, regardless of the applicability of universal calibration. For many practical polymer applications the intrinsic viscosity distribution will be nearly as useful as the molecular weight distribution.

The assistance of Dwight R. Hayes, Jr., in all phases of this work is gratefully acknowledged.

References

1. R. C. Jordan, *J. Liq. Chromatogr.*, **3**, 439-463 (1980).
2. M. Benoit, F. Grubisic, and R. Rempp, *J. Polym. Sci. B*, **5**, 753 (1967).
3. W. W. Fish, J. A. Reynolds, and C. Tanford, *J. Biol. Chem.*, **245**, 5166-5168 (1970).
4. R. P. Frigon, J. K. Leyboldt, S. Uyeji, and L. W. Henderson, *Anal. Chem.*, **55**, 1349-1354 (1983).
5. A. C. Ouano, *J. Polym. Sci., A-1*, **10**, 2169-2180 (1972).
6. D. Lecacheux, J. Leseq, and C. Quivoron, *J. Appl. Polym. Sci.*, **27**, 4867-4877 (1982).
7. F. B. Malihu, C. Kuo, M. E. Koehler, T. Provder, and A. F. Kah, *Prepr., Org. Coat. Plast. Chem., Div. Am. Chem. Soc., Seattle 1983*, p. 760.
8. M. A. Haney, JAPS 5691.

Received October 22, 1984

Accepted November 19, 1984